

December 2012

 No. OCH449
 REVISED EDITION-A

TECHNICAL & SERVICE MANUAL

Series PCFY Ceiling Suspended R410A

 Indoor unit
 [Model names]

PCFY-P40VKM-E

PCFY-P63VKM-E

PCFY-P100VKM-E

PCFY-P125VKM-E

[Service Ref.]

PCFY-P40VKM-E
PCFY-P40VKM-ER1
PCFY-P63VKM-E
PCFY-P63VKM-ER1
PCFY-P100VKM-E
PCFY-P100VKM-ER1
PCFY-P125VKM-E
PCFY-P125VKM-ER1

Revision:

- PCFY-P40/63/100/125VKM-ER1 have been added in REVISED EDITION-A.
- Some descriptions have been modified.

- Please void OCH449.

Note:

- This manual describes only service data of the indoor units.
- RoHS compliant products have <G> mark on the spec name plate.

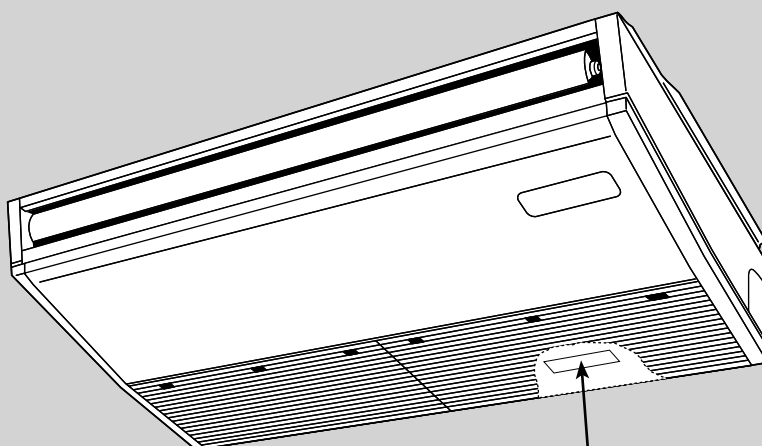

INDOOR UNIT

 Model name
 indication

CONTENTS

1. TECHNICAL CHANGES.....	2
2. SAFETY PRECAUTION.....	2
3. PART NAMES AND FUNCTIONS	4
4. SPECIFICATION	11
5. OUTLINES AND DIMENSIONS.....	15
6. WIRING DIAGRAM	18
7. REFRIGERANT SYSTEM DIAGRAM.....	20
8. TROUBLESHOOTING	21
9. DISASSEMBLY PROCEDURE	30

PARTS CATALOG (OCB449)

1

TECHNICAL CHANGES

- PCFY-P40VKM-E → PCFY-P40VKM-ER1
- PCFY-P63VKM-E → PCFY-P63VKM-ER1
- PCFY-P100VKM-E → PCFY-P100VKM-ER1
- PCFY-P125VKM-E → PCFY-P125VKM-ER1

• INDOOR CONTROLLER BOARD (I.B.) has been changed. (S/W version up)

2

SAFETY PRECAUTION

Cautions for units utilizing refrigerant R410A

Do not use the existing refrigerant piping.

The old refrigerant and lubricant in the existing piping contains a large amount of chlorine which may cause the lubricant deterioration of the new unit.

Use "low residual oil piping"

If there is a large amount of residual oil (hydraulic oil, etc.) inside the piping and joints, deterioration of the lubricant will result.

Store the piping indoors, and both ends of the piping sealed until just before brazing. (Leave elbow joints, etc. in their packaging.)

If dirt, dust or moisture enters into refrigerant cycle, that can cause deterioration of refrigerant oil or malfunction of compressor.

The refrigerant oil applied to flare and flange connections must be ester oil, ether oil or alkylbenzene oil in a small amount.

If large amount of mineral oil enters, that can cause deterioration of refrigerant oil etc.

Charge refrigerant from liquid phase of gas cylinder.

If the refrigerant is charged from gas phase, composition change may occur in refrigerant and the efficiency will be lowered.

Do not use refrigerant other than R410A.

If other refrigerant (R22 etc.) is used, chlorine in refrigerant can cause deterioration of refrigerant oil etc.

Use a vacuum pump with a reverse flow check valve.

Vacuum pump oil may flow back into refrigerant cycle and that can cause deterioration of refrigerant oil etc.

Use the following tools specifically designed for use with R410A refrigerant.

The following tools are necessary to use R410A refrigerant.

Tools for R410A	
Gauge manifold	Flare tool
Charge hose	Size adjustment gauge
Gas leak detector	Vacuum pump adaptor
Torque wrench	Electronic refrigerant charging scale

Handle tools with care.

If dirt, dust or moisture enters into refrigerant cycle, that can cause deterioration of refrigerant oil or malfunction of compressor.

Do not use a charging cylinder.

If a charging cylinder is used, the composition of refrigerant will change and the efficiency will be lowered.

Use the specified refrigerant only.

Never use any refrigerant other than that specified.

Doing so may cause a burst, an explosion, or fire when the unit is being used, serviced, or disposed of.

Correct refrigerant is specified in the manuals and on the spec labels provided with our products.

We will not be held responsible for mechanical failure, system malfunction, unit breakdown or accidents caused by failure to follow the instructions.

Ventilate the room if refrigerant leaks during operation. If refrigerant comes into contact with a flame, poisonous gases will be released.

[1] Cautions for service

- (1) Perform service after recovering the refrigerant left in unit completely.
- (2) Do not release refrigerant in the air.
- (3) After completing service, charge the cycle with specified amount of refrigerant.
- (4) When performing service, install a filter drier simultaneously.
Be sure to use a filter drier for new refrigerant.

[2] Additional refrigerant charge

When charging directly from cylinder

- Check that cylinder for R410A on the market is syphon type.
- Charging should be performed with the cylinder of syphon standing vertically. (Refrigerant is charged from liquid phase.)

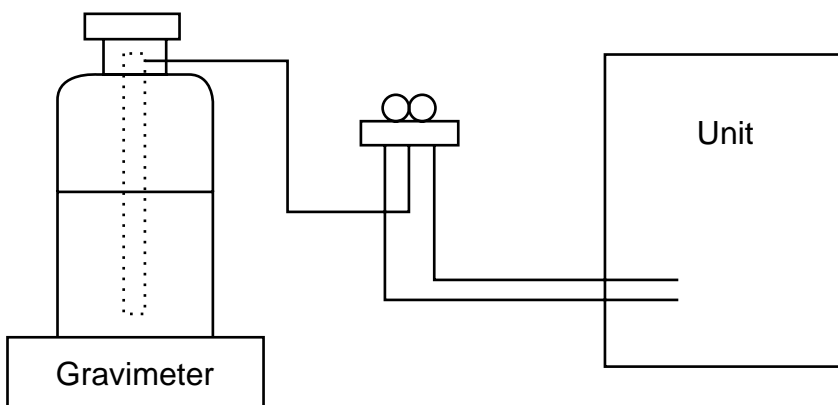

[3] Service tools

Use the below service tools as exclusive tools for R410A refrigerant.

No.	Tool name	Specifications
①	Gauge manifold	<ul style="list-style-type: none"> · Only for R410A · Use the existing fitting specifications. (UNF1/2) · Use high-tension side pressure of 5.3MPa-G or over.
②	Charge hose	<ul style="list-style-type: none"> · Only for R410A · Use pressure performance of 5.09MPa-G or over.
③	Electronic scale	—
④	Gas leak detector	· Use the detector for R134a, R407C or R410A.
⑤	Adaptor for reverse flow check	· Attach on vacuum pump.
⑥	Refrigerant charge base	—
⑦	Refrigerant cylinder	<ul style="list-style-type: none"> · Only for R410A · Top of cylinder (Pink) · Cylinder with syphon
⑧	Refrigerant recovery equipment	—

3-1. INDOOR UNIT

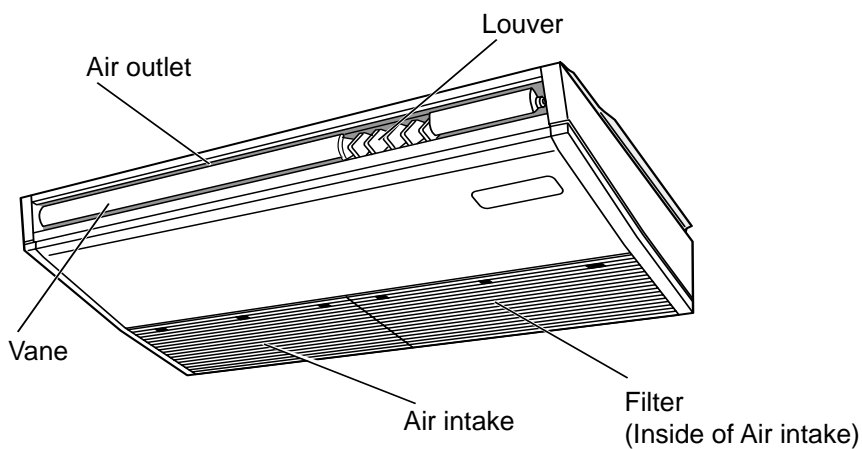

3-2. WIRED REMOTE CONTROLLER <PAR-30MAA/PAR-31MAA>

Wired remote controller function

* The functions which can be used are restricted according to the model.

○ : Supported ✕ : Unsupported

	Function	PAR-30MAA/PAR-31MAA		PAR-21MAA
		Slim	City multi	
Body	Product size H x W x D (mm)	120 x 120 x 19		120 x 130 x 19
	LCD	Full Dot LCD		Partial Dot LCD
	Backlight	○		✕
Energy-saving	Energy-saving operation schedule	○	✕	✕
	Automatic return to the preset temperature	○		✕
Restriction	Setting the temperature range restriction	○		○
Function	Operation lock function	○		○
	Weekly timer	○		✕
	On / Off timer	○		○
	High Power	○	✕	✕
	Manual vane angle	○		○

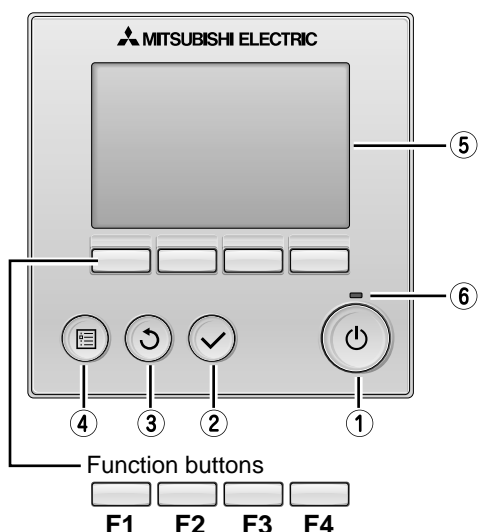

① ON / OFF button

Press to turn ON/OFF the indoor unit.

② SELECT button

Press to save the setting.

③ RETURN button

Press to return to the previous screen.

④ MENU button

Press to bring up the Main menu.

⑤ Backlit LCD

Operation settings will appear. When the backlight is off, pressing any button turns the backlight on and it will stay lit for a certain period of time depending on the screen.

When the backlight is off, pressing any button turns the backlight on and does not perform its function. (except for the (1) (ON / OFF) button)

The functions of the function buttons change depending on the screen. Refer to the button function guide that appears at the bottom of the LCD for the functions they serve on a given screen.

When the system is centrally controlled, the button function guide that corresponds to the locked button will not appear.

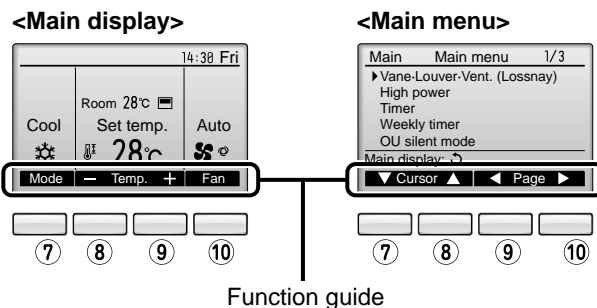

⑥ ON / OFF lamp

This lamp lights up in green while the unit is in operation. It blinks while the remote controller is starting up or when there is an error.

⑦ Function button F1

Main display : Press to change the operation mode.
Main menu : Press to move the cursor down.

⑧ Function button F2

Main display : Press to decrease temperature.
Main menu : Press to move the cursor up.

⑨ Function button F3

Main display : Press to increase temperature.
Main menu : Press to go to the previous page.

⑩ Function button F4

Main display : Press to change the fan speed.
Main menu : Press to go to the next page.

The main display can be displayed in two different modes: "Full" and "Basic".
The factory setting is "Full". To switch to the "Basic" mode, change the setting on the Main display setting.

<Full mode>

* All icons are displayed for explanation.

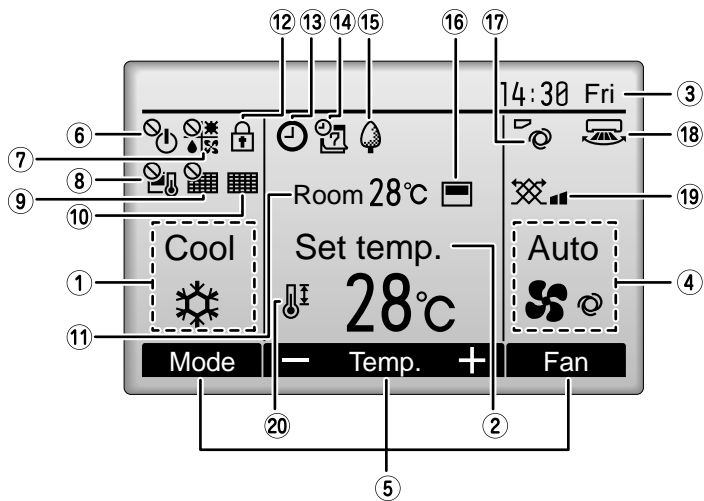

<Basic mode>

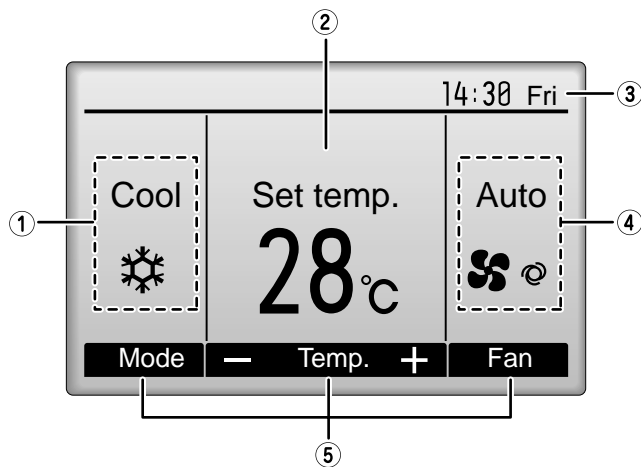

① Operation mode

Indoor unit operation mode appears here.

② Preset temperature

Preset temperature appears here.

③ Clock (See the Installation Manual.)

Current time appears here.

④ Fan speed

Fan speed setting appears here.

⑤ Button function guide

Functions of the corresponding buttons appear here.

⑥

Appears when the ON/OFF operation is centrally controlled.

⑦

Appears when the operation mode is centrally controlled.

⑧

Appears when the preset temperature is centrally controlled.

⑨

Appears when the filter reset function is centrally controlled.

⑩

Indicates when filter needs maintenance.

⑪ Room temperature (See the Installation Manual.)

Current room temperature appears here.

⑫

Appears when the buttons are locked.

⑬

Appears when the On/Off timer or Night setback function is enabled.

⑭

Appears when the Weekly timer is enabled.

⑮

Appears while the units are operated in the energy-save mode.

⑯

Appears when the built-in thermistor on the remote controller is activated to monitor the room temperature.

⑰

appears when the thermistor on the indoor unit is activated to monitor the room temperature.

⑱

Indicates the vane setting.

⑲

Indicates the louver setting.

⑳

Indicates the ventilation setting.

㉑

Indicates the restricted temperature range setting.

㉒

Appears when the preset temperature range is restricted.

Most settings (except ON / OFF, mode, fan speed, temperature) can be made from the Menu screen.



Menu structure

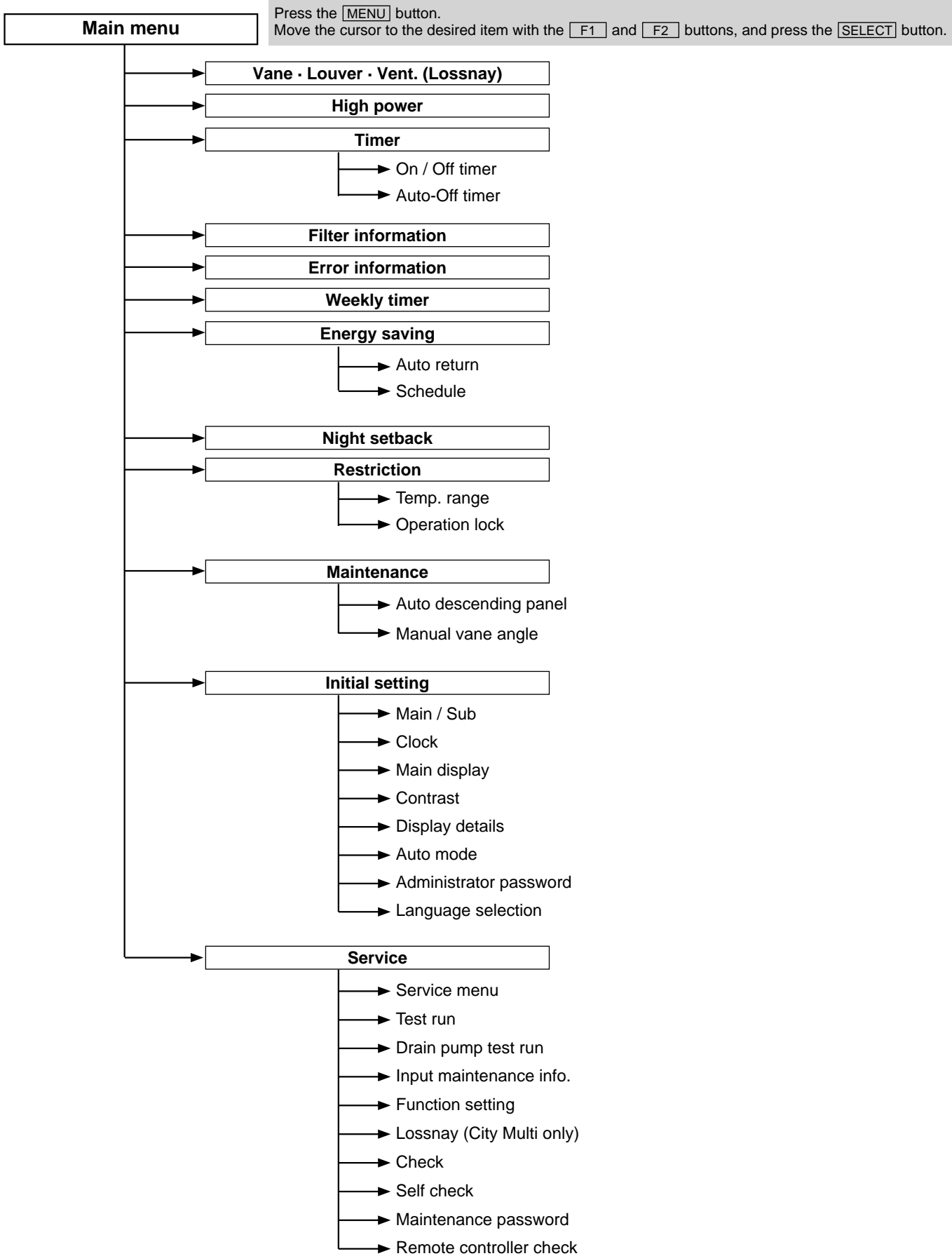

Not all functions are available on all models of indoor units.



Main menu list

Setting and display items		Setting details
Vane · Louver · Vent. (Lossnay)		<p>Use to set the vane angle.</p> <ul style="list-style-type: none"> • Select a desired vane setting from five different settings. <p>Use to turn ON / OFF the louver.</p> <ul style="list-style-type: none"> • Select a desired setting from "ON" and "OFF." <p>Use to set the amount of ventilation.</p> <ul style="list-style-type: none"> • Select a desired setting from "Off," "Low," and "High."
High power		<p>Use to reach the comfortable room temperature quickly.</p> <ul style="list-style-type: none"> • Units can be operated in the High-power mode for up to 30 minutes.
Timer	On/Off timer	<p>Use to set the operation On/Off times.</p> <ul style="list-style-type: none"> • Time can be set in 5-minute increments. * Clock setting is required.
	Auto-Off timer	<p>Use to set the Auto-Off time.</p> <ul style="list-style-type: none"> • Time can be set to a value from 30 to 240 in 10-minute increments.
Filter information		<p>Use to check the filter status.</p> <ul style="list-style-type: none"> • The filter sign can be reset.
Error information		<p>Use to check error information when an error occurs.</p> <ul style="list-style-type: none"> • Error code, error source, refrigerant address, unit model, manufacturing number, contact information (dealer's phone number) can be displayed. * The unit model, manufacturing number, and contact information need to be registered in advance to be displayed.
Weekly timer		<p>Use to set the weekly operation On / Off times.</p> <ul style="list-style-type: none"> • Up to eight operation patterns can be set for each day. * Clock setting is required. * Not valid when the On/Off timer is enabled.
Energy saving	Auto return	<p>Use to get the units to operate at the preset temperature after performing energy-save operation for a specified time period.</p> <ul style="list-style-type: none"> • Time can be set to a value from 30 and 120 in 10-minute increments. * This function will not be valid when the preset temperature ranges are restricted.
	Schedule	<p>Set the start/stop times to operate the units in the energy-save mode for each day of the week, and set the energy-saving rate.</p> <ul style="list-style-type: none"> • Up to four energy-save operation patterns can be set for each day. • Time can be set in 5-minute increments. • Energy-saving rate can be set to a value from 0% or 50 to 90% in 10% increments. * Clock setting is required.
Night setback		<p>Use to make Night setback settings.</p> <ul style="list-style-type: none"> • Select "Yes" to enable the setting, and "No" to disable the setting. The temperature range and the start/stop times can be set. * Clock setting is required.
Restriction	Temp. range	<p>Use to restrict the preset temperature range.</p> <ul style="list-style-type: none"> • Different temperature ranges can be set for different operation modes.
	Operation lock	<p>Use to lock selected functions.</p> <ul style="list-style-type: none"> • The locked functions cannot be operated.
Maintenance	Auto descending panel	<p>Auto descending panel (Optional parts) Up / Down you can do.</p>
	Manual vane angle	<p>Use to set the vane angle for each vane to a fixed position.</p>
Initial setting	Main/Sub	<p>When connecting two remote controllers, one of them needs to be designated as a sub controller.</p>
	Clock	<p>Use to set the current time.</p>
	Main display	<p>Use to switch between "Full" and "Basic" modes for the Main display.</p> <ul style="list-style-type: none"> • The default setting is "Full."
	Contrast	<p>Use to adjust screen contrast.</p>



Setting and display items		Setting details
Initial setting	Display details	<p>Make the settings for the remote controller related items as necessary.</p> <p>Clock: The factory settings are "Yes" and "24h" format.</p> <p>Temperature: Set either Celsius (°C) or Fahrenheit (°F).</p> <p>Room temp. : Set Show or Hide.</p> <p>Auto mode: Set the Auto mode display or Only Auto display.</p>
	Auto mode	<p>Whether or not to use the AUTO mode can be selected by using the button.</p> <p>This setting is valid only when indoor units with the AUTO mode function are connected.</p>
	Administrator password	<p>The administrator password is required to make the settings for the following items.</p> <ul style="list-style-type: none"> • Timer setting • Energy-save setting • Weekly timer setting • Restriction setting • Outdoor unit silent mode setting • Night set back
	Language selection	<p>Use to select the desired language.</p>
Service	Test run	<p>Select "Test run" from the Service menu to bring up the Test run menu.</p> <ul style="list-style-type: none"> • Test run • Drain pump test run
	Input maintenance	<p>Select "Input maintenance Info." from the Service menu to bring up the Maintenance information screen.</p> <p>The following settings can be made from the Maintenance Information screen.</p> <ul style="list-style-type: none"> • Model name input • Serial No. input • Dealer information input
	Function setting	<p>Make the settings for the indoor unit functions via the remote controller as necessary.</p>
	LOSSNAY setting (City Multi only)	<p>This setting is required only when the operation of City Multi units is interlocked with LOSSNAY units.</p>
	Check	<p>Error history: Display the error history and execute delete error history.</p> <p>Refrigerant leak check: Refrigerant leaks can be judged.</p> <p>Smooth maintenance: The indoor and outdoor maintenance data can be displayed.</p> <p>Request cord: Details of the operation data including each thermistor temperature and error history can be checked.</p>
	Self check	<p>Error history of each unit can be checked via the remote controller.</p>
	Maintenance password	<p>Take the following steps to change the maintenance password.</p>
	Remote controller check	<p>When the remote controller does not work properly, use the remote controller checking function to troubleshoot the problem.</p>

3-3. WIRED REMOTE CONTROLLER <PAR-21MAA>

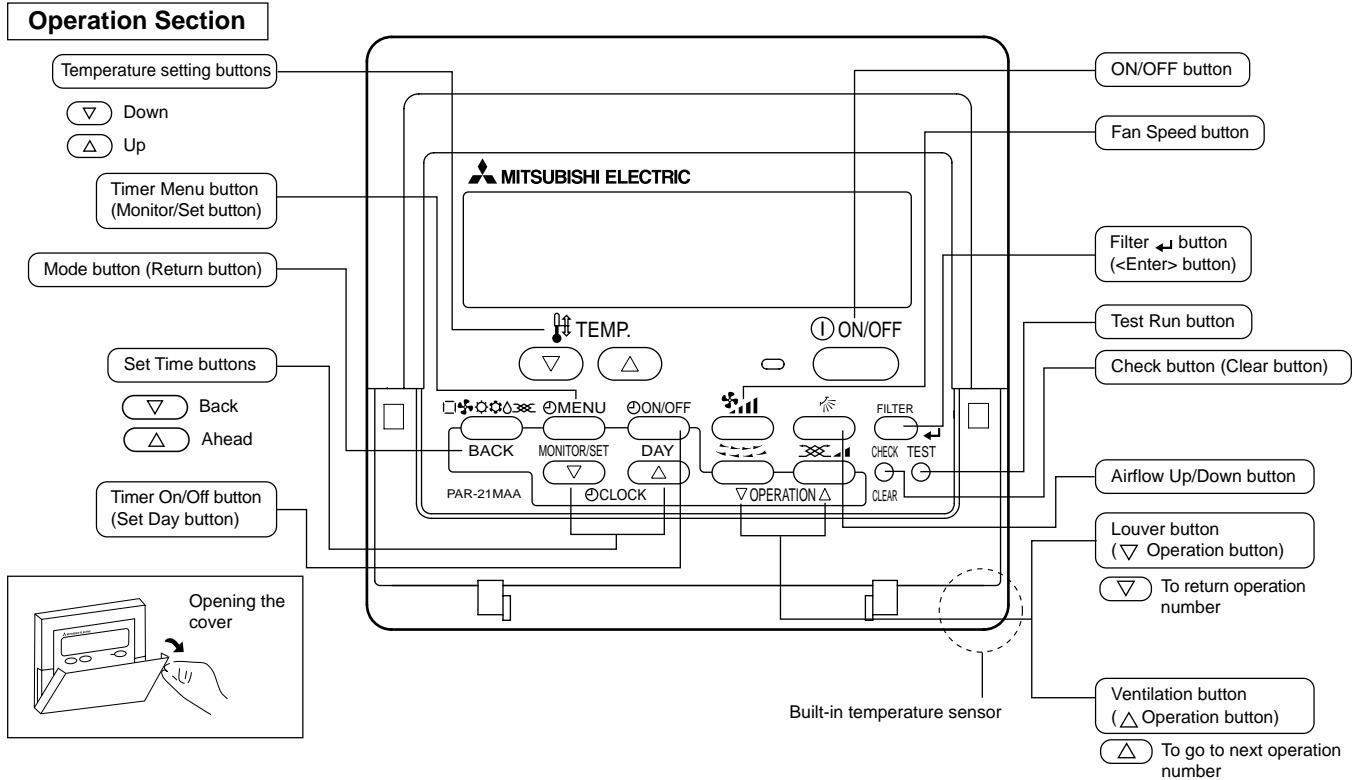
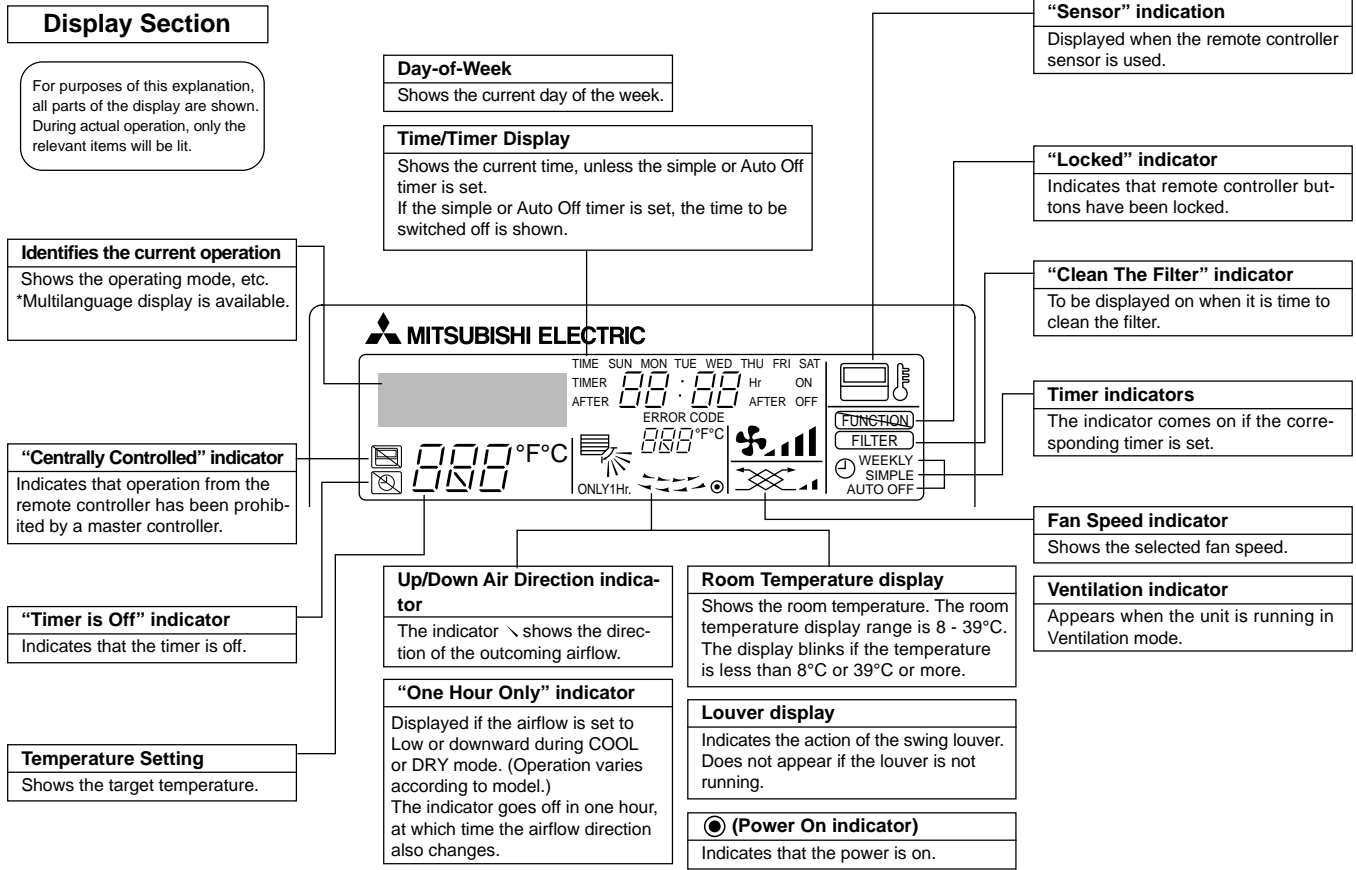

4

SPECIFICATION

4-1. SPECIFICATIONS

Model		PCFY-P40VKM-E	PCFY-P63VKM-E	PCFY-P100VKM-E	PCFY-P125VKM-E	
Power source		1-phase 220-240V 50Hz, 1-phase 220V 60Hz				
Cooling capacity (Nominal)	*1 kW	4.5	7.1	11.2	14.0	
	*1 kcal/h	3,900	6,100	9,600	12,000	
	*1 Btu/h	15,400	24,200	38,200	47,800	
	*2 kcal/h	4,000	6,300	10,000	12,500	
	Power input	0.040	0.050	0.090	0.110	
	Current input	A	0.28	0.33	0.65	0.76
Heating capacity (Nominal)	*3 kW	5.0	8.0	12.5	16.0	
	*3 kcal/h	4,300	6,900	10,800	13,800	
	*3 Btu/h	17,100	27,300	42,700	54,600	
	Power input	0.040	0.050	0.090	0.110	
	Current input	A	0.28	0.33	0.65	0.76
External finish		MUNSELL (6.4Y 8.9/0.4)				
External dimensions H x W x D		mm	230x960x680	230x1280x680	230x1600x680	
		in.	9-1/16x37-13/16x26-3/4	9-1/16x50-3/8x26-3/4	9-1/16x63x26-3/4	
Net weight		kg (lb)	24 (53)	32 (71)	36 (79)	38 (84)
Heat exchanger		Cross fin (Aluminum fin and copper tube)				
FAN	Type x quantity	Sirocco fan x 2	Sirocco fan x 3	Sirocco fan x 4		
	External static press.	Pa	0			
		mmH ₂ O	0			
	Motor type	DC motor				
	Motor output	kW	0.090	0.095	0.160	
	Driving mechanism	Direct-driven by motor				
	Airflow rate (Low-Mid2-Mid1-High)	m ³ /min	10-11-12-13	14-15-16-18	21-24-26-28	21-24-27-31
	L/s	167-183-200-217	233-250-267-300	350-400-433-467	350-400-450-517	
	cfm	353-388-424-459	494-530-565-636	742-847-918-989	742-847-953-1095	
Noise level (Low-Mid2-Mid1-High) (measured in anechoic room)	dB <A>	29-32-34-36	31-33-35-37	36-38-41-43	36-39-42-44	
Insulation material		Polyeter sheet				
Air filter		PP honeycomb				
Protection device		Fuse				
Refrigerant control device		LEV				
Connectable outdoor unit		R410A CITY MULTI				
Diameter of refrigerant pipe	Liquid	mm(in.)	ø6.35 (ø1/4) Flare	ø9.52 (ø3/8) Flare	ø9.52 (ø3/8) Flare	ø9.52 (ø3/8) Flare
	Gas	mm(in.)	ø12.7 (ø1/2) Flare	ø15.88 (ø5/8) Flare	ø19.05 (ø3/4) Flare	ø19.05 (ø3/4) Flare
Field drain pipe size		mm(in.)	O.D. 26mm (1)			
Standard attachment	Document	Installation Manual, Instruction Book				
	Accessory					
Optional parts	Drain pump kit	PAC-SH83DM-E	PAC-SH84DM-E			
	High efficiency filter	PAC-SH88KF-E	PAC-SH89KF-E	PAC-SH90KF-E		
	Wireless remote controller kit	PAR-SL94B-E				
Remarks	Installation	Details on foundation work, insulation work, electrical wiring, power source switch, and other items shall be referred to the Installation Manual.				
Note :		*1 Nominal cooling conditions	*2 Nominal cooling conditions	*3 Nominal heating conditions	Unit converter	
	Indoor :	27°CDB/19°CWB (81°FDB/66°FWB)	27°CDB/19.5°CWB (81°FDB/67°FWB)	20°CDB (68°FDB)	kcal/h = kW x 860	
	Outdoor :	35°CDB (95°FDB)	35°CDB (95°FDB)	7°CDB/6°CWB (45°FDB/43°FWB)	Btu/h = kW x 3,412	
	Pipe length :	7.5 m (24-9/16 ft)	5 m (16-3/8 ft)	7.5 m (24-9/16 ft)	cfm = m ³ /min x 35.31	
	Level difference :	0 m (0 ft)	0 m (0 ft)	0 m (0 ft)	lb = kg/0.4536	
* Nominal conditions *1, *3 are subject to JIS B8615-1.					*Above specification data is subject to rounding variation.	
* Due to continuing improvement, above specification may be subject to change without notice.						

4-2. ELECTRICAL PARTS SPECIFICATIONS

Service Ref. Parts name	Symbol	PCFY-P40VKM-E PCFY-P40VKM-ER1	PCFY-P63VKM-E PCFY-P63VKM-ER1	PCFY-P100VKM-E PCFY-P125VKM-E PCFY-P100VKM-ER1 PCFY-P125VKM-ER1
Room temperature thermistor	TH21	Resistance 0°C/15kΩ, 10°C/9.6kΩ, 20°C/6.3kΩ, 25°C/5.4kΩ, 30°C/4.3kΩ, 40°C/3.0kΩ		
Liquid pipe thermistor	TH22	Resistance 0°C/15kΩ, 10°C/9.6kΩ, 20°C/6.3kΩ, 25°C/5.4kΩ, 30°C/4.3kΩ, 40°C/3.0kΩ		
Gas pipe thermistor	TH23	Resistance 0°C/15kΩ, 10°C/9.6kΩ, 20°C/6.3kΩ, 25°C/5.4kΩ, 30°C/4.3kΩ, 40°C/3.0kΩ		
Fuse (Indoor controller board)	FUSE	250V 6.3A		
Fan motor	MF	8-pole OUTPUT 90W	8-pole OUTPUT 95W	8-pole OUTPUT 160W
Vane motor	MV	MSBPC20 DC12V 300Ω/phase		
Drain-pump (Option)	DP	INPUT 12/10.8W 24ℓ/Hr		
Drain float switch	FS	Open / Short detection DC 5V		
Linear expansion valve	LEV	DC12V Stepping motor drive Port dimension ø3.2 (0~2000pulse) EFM-40YGME	DC12V Stepping motor drive Port dimension ø5.2 (0~2000pulse) EFM-80YGME	
Power supply terminal block	TB2	(L, N, ⊕) Rated to 330V 30A *		
Transmission terminal block	TB5	(M1, M2, S) Rated to 250V 20A *		
MA remote controller terminal block	TB15	(1, 2) Rated to 250V 10A *		

* Refer to WIRING DIAGRAM for the supplied voltage.

4-3. SOUND LEVEL

PCFY-P-VKM-E

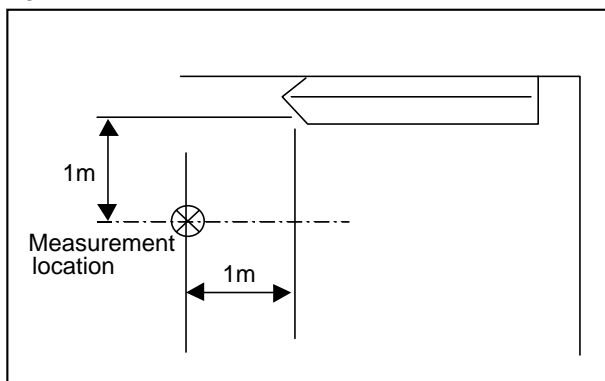

Sound level at anechoic room : Low-Mid2-Mid1-High

Service Ref.	Sound level dB (A)
PCFY-P40VKM-E PCFY-P40VKM-ER1	29-32-34-36
PCFY-P63VKM-E PCFY-P63VKM-ER1	31-33-35-37
PCFY-P100VKM-E PCFY-P100VKM-ER1	36-38-41-43
PCFY-P125VKM-E PCFY-P125VKM-ER1	36-39-42-44

* Measured in anechoic room.

4-4. NC CURVES

PCFY-P40VKM-E PCFY-P40VKM-ER1

External static pressure : 0Pa
Power source : 220,230,240V, 50Hz / 220V, 60Hz

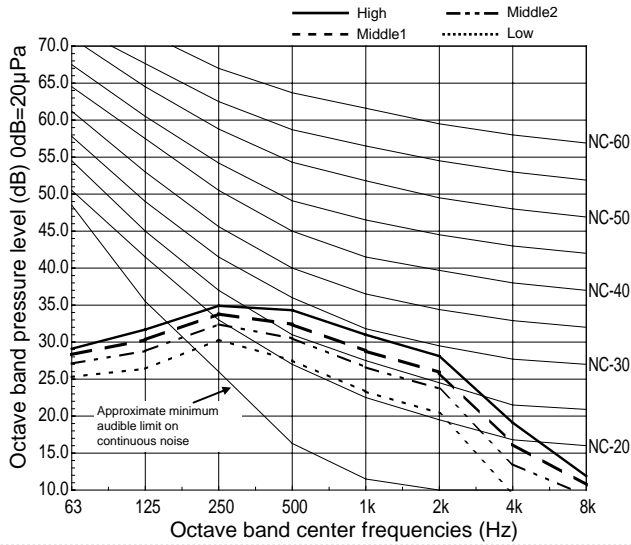

PCFY-P63VKM-E PCFY-P63VKM-ER1

External static pressure : 0Pa
Power source : 220,230,240V, 50Hz / 220V, 60Hz

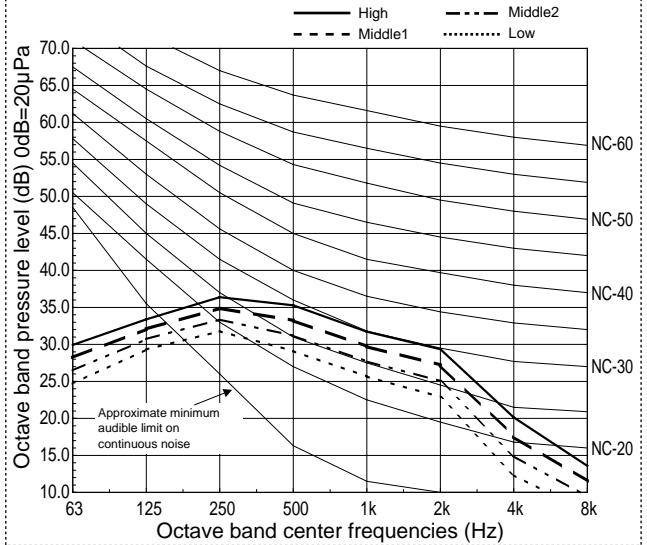

PCFY-P100VKM-E PCFY-P100VKM-ER1

External static pressure : 0Pa
Power source : 220,230,240V, 50Hz / 220V, 60Hz

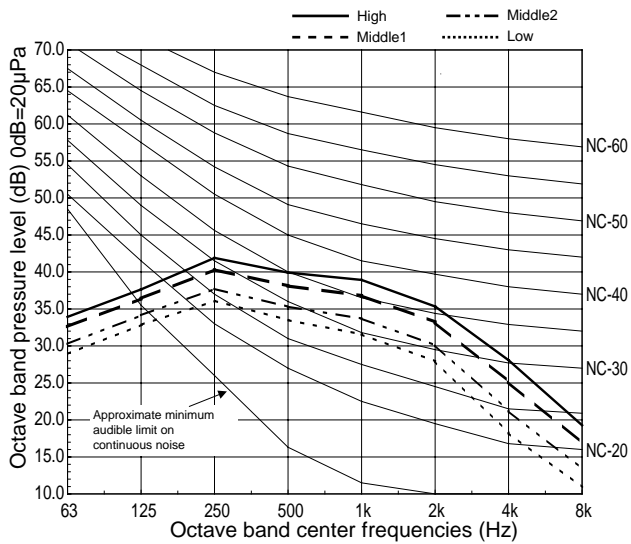

PCFY-P125VKM-E PCFY-P125VKM-ER1

External static pressure : 0Pa
Power source : 220,230,240V, 50Hz / 220V, 60Hz

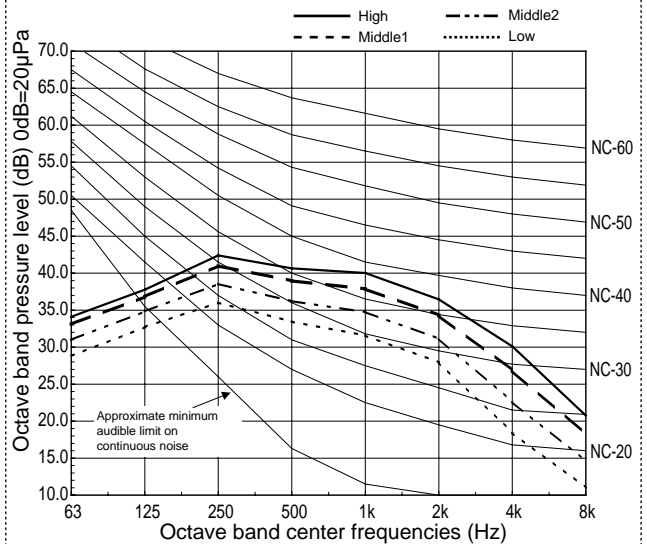

4-5. FRESH AIR INTAKE AMOUNT & STATIC PRESSURE CHARACTERISTICS

PCFY-P40VKM-E PCFY-P40VKM-ER1



PCFY-P63VKM-E PCFY-P63VKM-ER1

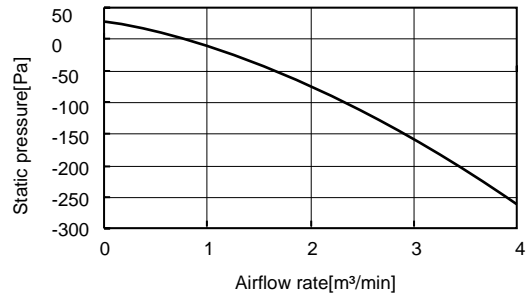

PCFY-P100, 125VKM-E PCFY-P100, 125VKM-ER1



How to read curves

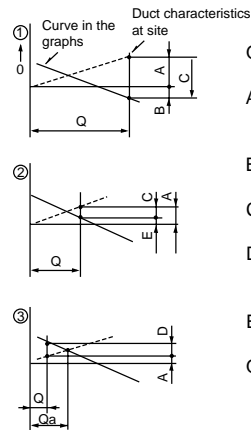

- Q...Designed amount of fresh air intake <m³/min>
- A...Static pressure loss of fresh air intake duct system with airflow amount Q <Pa>
- B...Forced static pressure at air conditioner inlet with airflow amount Q <Pa>
- C...Static pressure of booster fan with airflow amount Q <Pa>
- D...Static pressure loss increase amount of fresh air intake duct system for airflow amount Q <Pa>
- E...Static pressure of indoor unit with airflow amount Q <Pa>
- Qa...Estimated amount of fresh air intake without D <m³/min>

PCFY-P40VKM-E
PCFY-P40VKM-ER1

Unit : mm

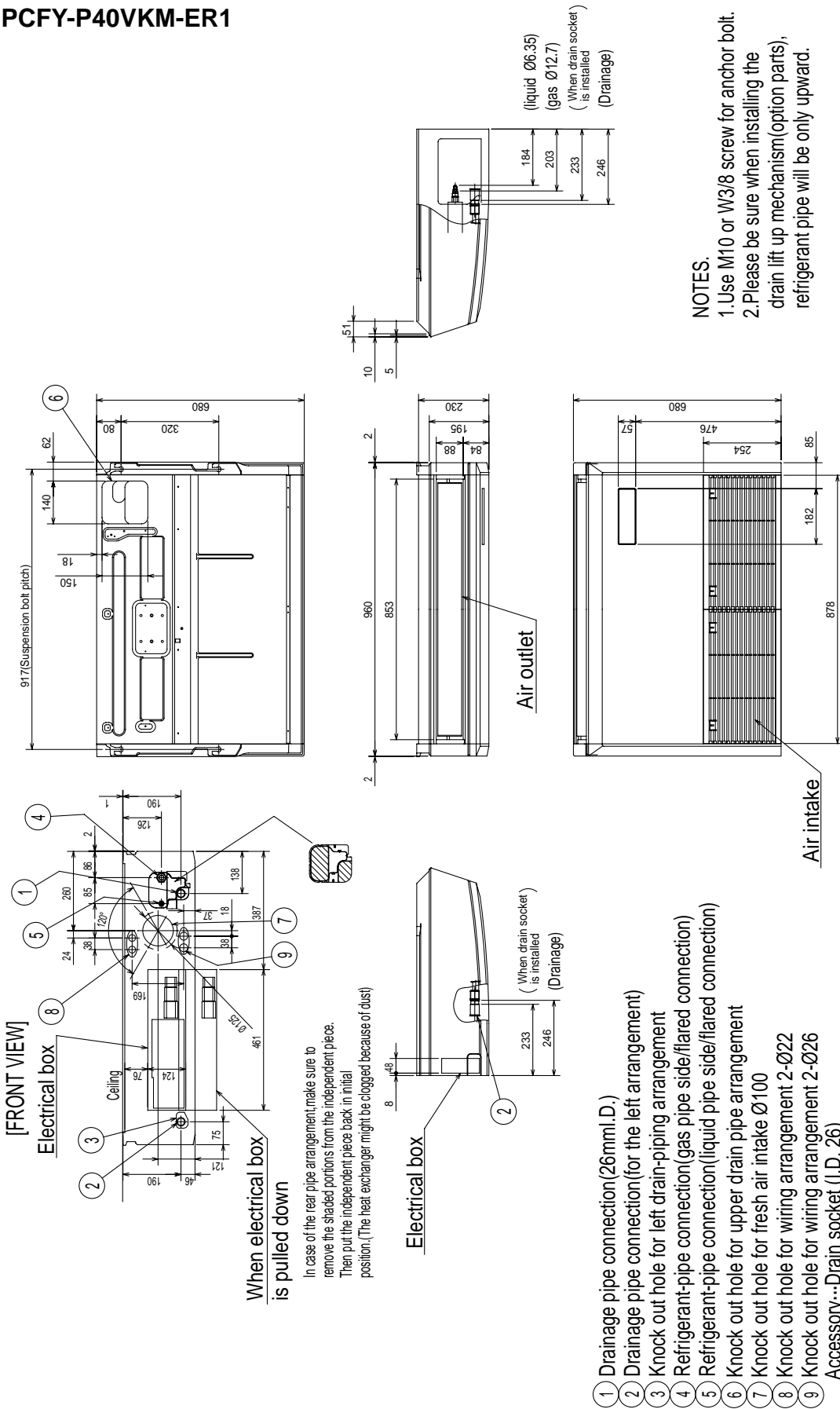

PCFY-P63VKM-E
PCFY-P63VKM-ER1

Unit : mm

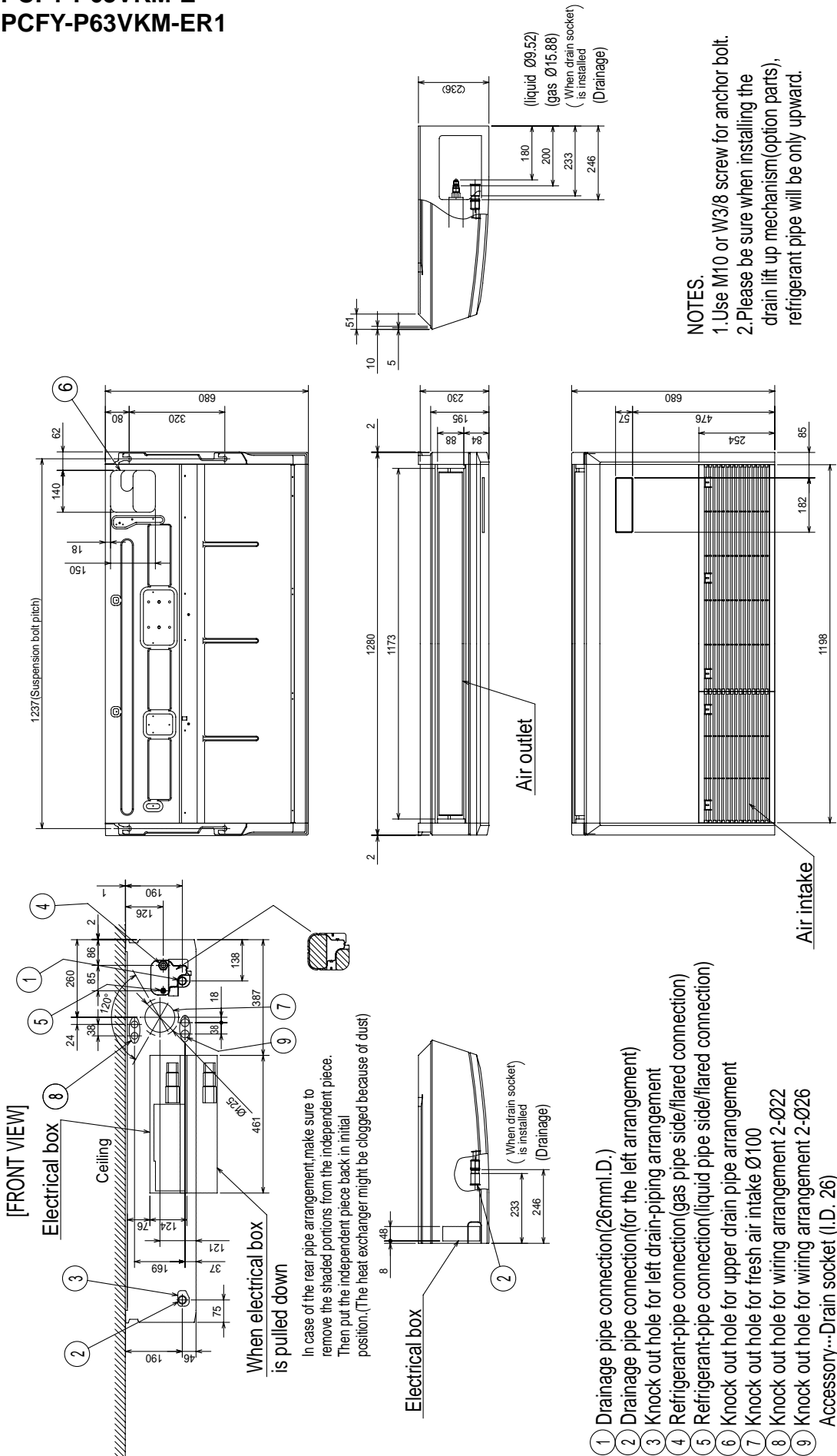

NOTES.
1. Use M10 or W3/8 screw for anchor bolt.
2. Please be sure when installing the drain lift up mechanism (option parts), refrigerant pipe will be only upward.

In case of the rear pipe arrangement, make sure to remove the shaded portions from the independent piece. Then put the independent piece back in initial position. (The heat exchanger might be clogged because of dust)

- ① Drainage pipe connection (26mm I.D.)
 - ② Drainage pipe connection (for the left arrangement)
 - ③ Knock out hole for left drain-piping arrangement
 - ④ Refrigerant-pipe connection (gas pipe side/flared connection)
 - ⑤ Refrigerant-pipe connection (liquid pipe side/flared connection)
 - ⑥ Knock out hole for upper drain pipe arrangement
 - ⑦ Knock out hole for fresh air intake Ø100
 - ⑧ Knock out hole for wiring arrangement 2-Ø22
 - ⑨ Knock out hole for wiring arrangement 2-Ø26
- Accessory... Drain socket (I.D. 26)

PCFY-P100VKM-E
PCFY-P125VKM-E
PCFY-P100VKM-ER1
PCFY-P125VKM-ER1

Unit : mm

- ⑥ Knock out hole for upper drain pipe arrangement
- ⑦ Knock out hole for fresh air intake Ø100
- ⑧ Knock out hole for wiring arrangement 2-Ø22
- ⑨ Knock out hole for wiring arrangement 2-Ø26
- Accessory...-Drain socket (I.D. 26)

- ① Drainage pipe connection (26mm I. D.)
- ② Drainage pipe connection (for the left arrangement)
- ③ Knock out hole for left drain-piping arrangement
- ④ Refrigerant-pipe connection (gas pipe side/flared connection)
- ⑤ Refrigerant-pipe connection (liquid pipe side/flared connection)

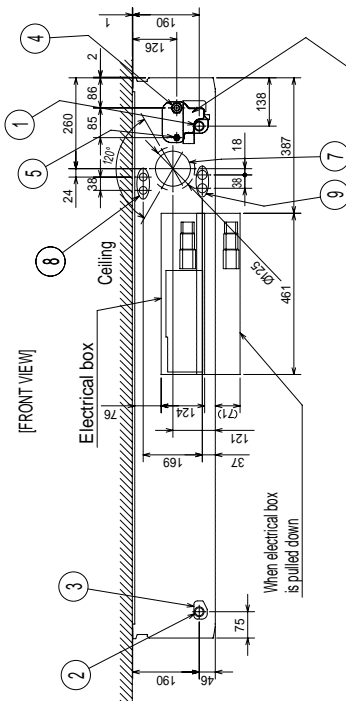

In case of the rear pipe arrangement, make sure to remove the shaded portions from the independent piece. Then put the independent piece back in initial position. (The heat exchanger might be clogged because of dust)

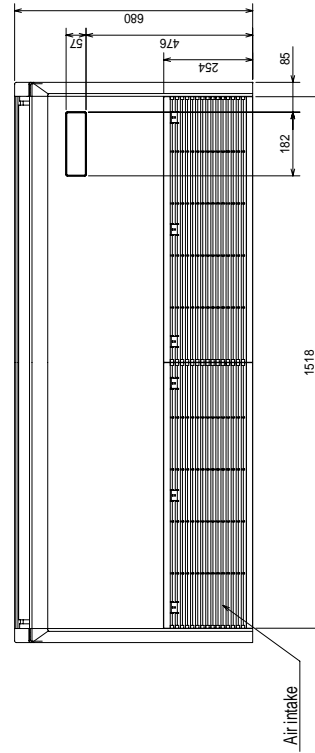
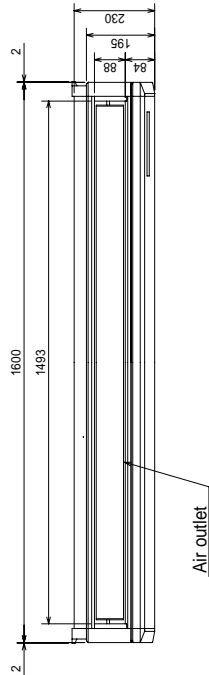
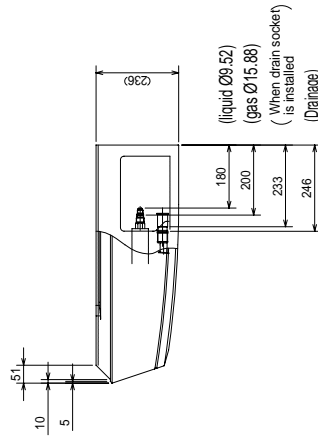

- NOTES.**
 1. Use M10 or W3/8 screw for anchor bolt.
 2. Please be sure when installing the drain lift up mechanism (option parts), refrigerant pipe will be only upward.

PCFY-P40VKM-E

PCFY-P63VKM-E

PCFY-P100VKM-E

PCFY-P125VKM-E

SYMBOL	NAME	SYMBOL	NAME
I. B	INDOOR CONTROLLER BOARD	TH22	THERMISTOR PIPE TEMP. DETECTION / LIQUID (0°C / 15kΩ, 25°C / 5.4kΩ)
CN27	CONNECTOR DAMPER	TH23	PIPE TEMP. DETECTION / GAS (0°C / 15kΩ, 25°C / 5.4kΩ)
CN32	REMOTE SWITCH	A. B	ADDRESS BOARD
CN51	CENTRALLY CONTROL	SWA	SWITCH CEILING HEIGHT SELECTOR
CN52	REMOTE INDICATION	SWC	OPTION SELECTOR
DSA	SURGE ABSORBER	SW1	MODE SELECTION
FUSE	FUSE (T6.3AL250V)	SW11	ADDRESS SETTING 1s DIGIT
SW2	SWITCH CAPACITY CODE	SW12	ADDRESS SETTING 10ths DIGIT
SW3	MODE SELECTION	SW14	BRANCH No.
SW4	MODEL SELECTION	OPTIONAL PARTS	
SWE	DRAIN PUMP (TEST MODE)	W.B	PCB FOR WIRELESS REMOTE CONTROLLER
X1	AUX. RELAY DRAIN PUMP (OPTIONAL PARTS)	BZ	BUZZER
ZNR01,02	VARISTOR	LED1	LED (OPERATION INDICATION : GREEN)
LEV	LINEAR EXPANSION VALVE	LED2	LED (PREPARATION FOR HEATING : ORANGE)
DCL	REACTOR	RU	RECEIVING UNIT
MF	FAN MOTOR	SW1	EMERGENCY OPERATION (HEAT / DOWN)
MV	VANE MOTOR	SW2	EMERGENCY OPERATION (COOL / UP)
TB2	TERMINAL BLOCK POWER SUPPLY	DP	DRAIN PUMP
TB5	BLOCK TRANSMISSION	FS	DRAIN FLOAT SWITCH
TB15	MA-REMOTE CONTROLLER		
TH21	THERMISTOR ROOM TEMP. DETECTION (0°C / 15kΩ, 25°C / 5.4kΩ)		

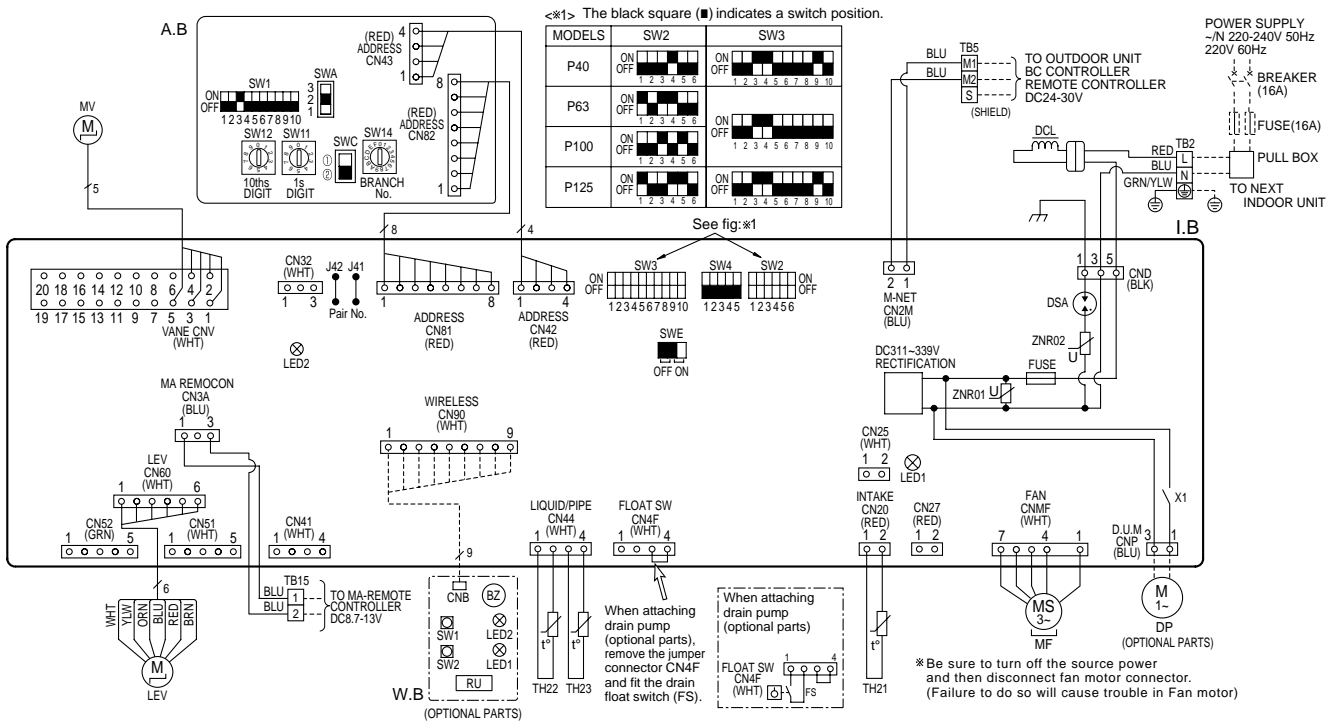

LED on indoor board for service

Mark	Meaning	Function
LED1	Main power supply	Main power supply (Indoor unit:220-240V) Power on → lamp is lit
LED2	Power supply for MA-Remote controller	Power supply for MA-Remote controller on → lamp is lit

NOTES:

- At servicing for outdoor unit, always follow the wiring diagram of outdoor unit.
- In case of using MA-Remote controller, please connect to TB15.
(Remote controller wire is non-polar.)
- In case of using M-NET, please connect to TB5. (Transmission line is non-polar.)
- Symbol [S] of TB5 is the shield wire connection.
- Symbols used in wiring diagram above are, []: terminal block, []: connector.
- The setting of the SW2 dip switches differs in the capacity. for the detail, refer to the fig.*1.

[LEGEND]

SYMBOL	NAME	SYMBOL	NAME
I, B	INDOOR CONTROLLER BOARD	TH22	THERMISTOR
CN27	CONNECTOR	TH23	THERMISTOR
CN32	CONNECTOR	A, B	ADDRESS BOARD
CN51	CONNECTOR	SWA	SWITCH
CN52	CONNECTOR	SWC	SWITCH
CN105	CONNECTOR	SW1	SWITCH
FUSE	FUSE (T6.3AL250V)	SW11	SWITCH
SW2	SWITCH	SW12	SWITCH
SW3	SWITCH	SW14	SWITCH
SW4	SWITCH	W, B	OPTIONAL PARTS
SWE	SWITCH	BZ	BUZZER
X1	AUX. RELAY	LED1	LED (OPERATION INDICATION : GREEN)
LEV	LINEAR EXPANSION VALVE	LED2	LED (PREPARATION FOR HEATING : ORANGE)
DCL	REACTOR	RU	RECEIVING UNIT
MF	FAN MOTOR	SW1	EMERGENCY OPERATION (HEAT / DOWN)
MV	VANE MOTOR	SW2	EMERGENCY OPERATION (COOL / UP)
TB2	TERMINAL BLOCK	DP	DRAIN PUMP
TB5	TERMINAL BLOCK	FS	DRAIN FLOAT SWITCH
TB15	TERMINAL BLOCK		
TH21	THERMISTOR		

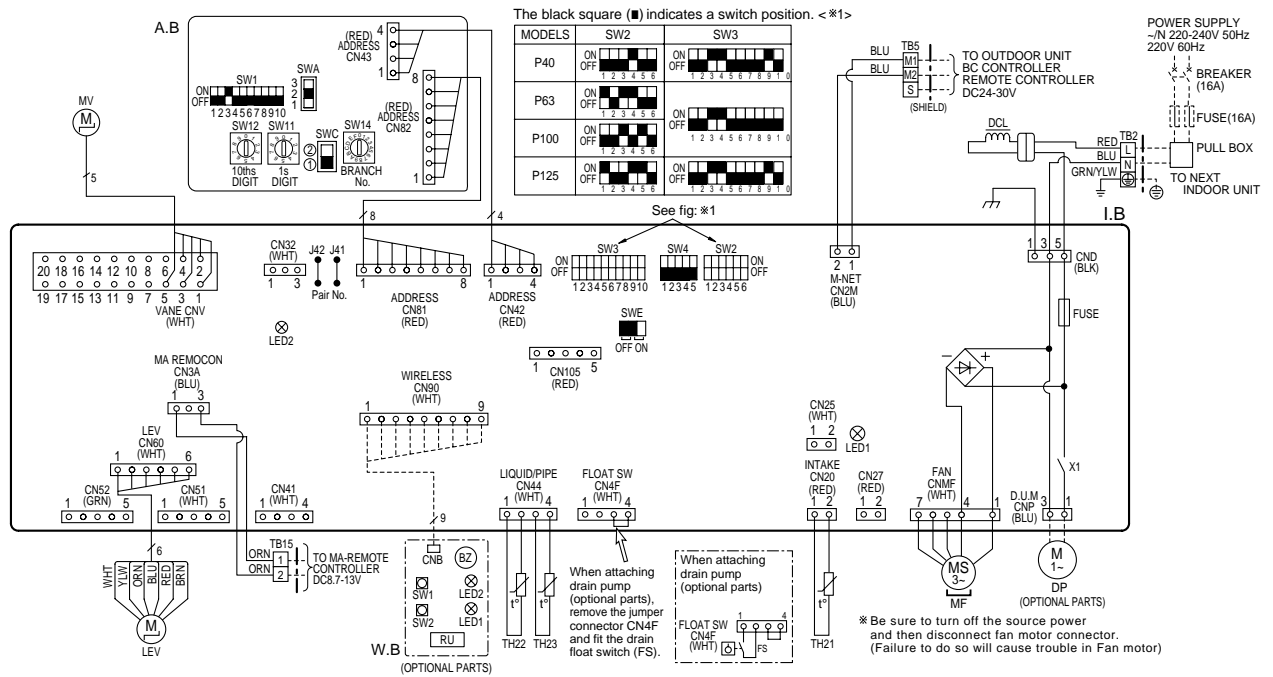

NOTES:

1. At servicing for outdoor unit, always follow the wiring diagram of outdoor unit.
2. In case of using MA-Remote controller, please connect to TB15.
(Remote controller wire is non-polar.)
3. In case of using M-NET, please connect to TB5. (Transmission line is non-polar.)
4. Symbol [S] of TB5 is the shield wire connection.
5. Symbols used in wiring diagram above are, □□□□ : terminal block, □□□□ : connector.
6. The setting of the SW2 dip switches differs in the capacity. For the detail, refer to fig < *1 >.

LED on indoor board for service

Mark	Meaning	Function
LED1	Main power supply	Main Power supply (Indoor unit:220-240V) power on → lamp is lit
LED2	Power supply for MA-Remote controller	Power supply for MA-Remote controller on → lamp is lit

7

REFRIGERANT SYSTEM DIAGRAM

PCFY-P40VKM-E
PCFY-P40VKM-ER1

PCFY-P63VKM-E
PCFY-P63VKM-ER1

PCFY-P100VKM-E
PCFY-P100VKM-ER1

PCFY-P125VKM-E
PCFY-P125VKM-ER1

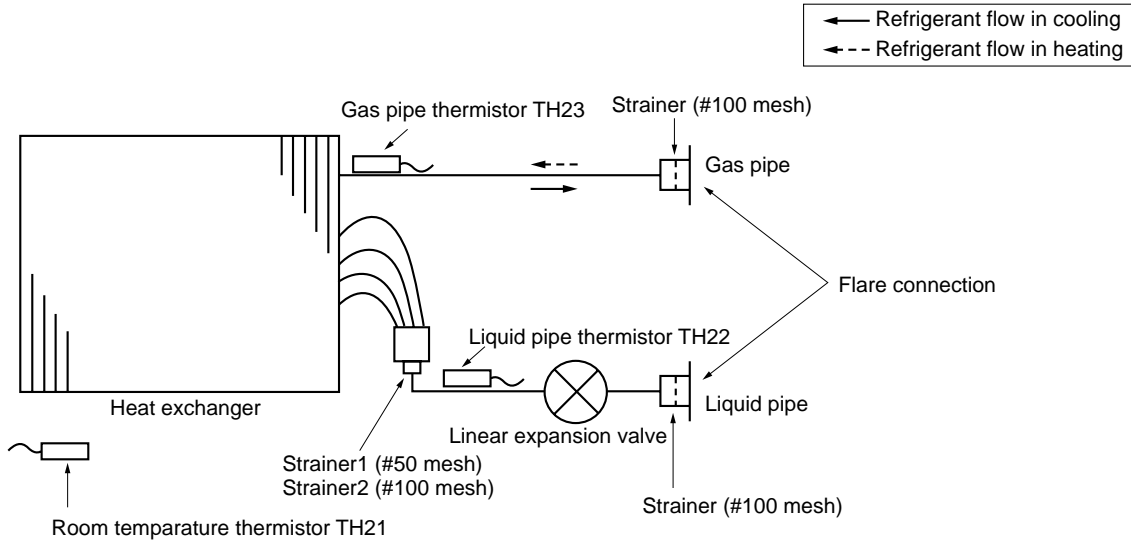

Unit : mm (inch)

Service Ref.	PCFY-P40VKM-E PCFY-P40VKM-ER1	PCFY-P63VKM-E, PCFY-P63VKM-ER1 PCFY-P100VKM-E, PCFY-P100VKM-ER1 PCFY-P125VKM-E, PCFY-P125VKM-ER1
Gas pipe	ø12.7 (1/2)	ø15.88 (5/8)
Liquid pipe	ø6.35 (1/4)	ø9.52 (3/8)

8

TROUBLESHOOTING

8-1. HOW TO CHECK THE PARTS

PCFY-P40VKM-E

PCFY-P63VKM-E

PCFY-P100VKM-E

PCFY-P125VKM-E

PCFY-P40VKM-ER1

PCFY-P63VKM-ER1

PCFY-P100VKM-ER1

PCFY-P125VKM-ER1

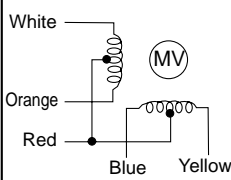
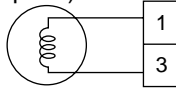
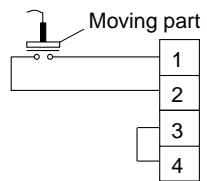
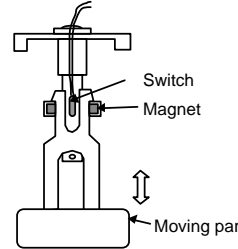
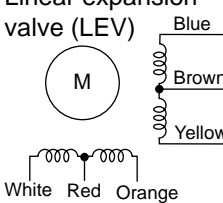
Parts name	Check points														
Room temperature thermistor (TH21) Liquid pipe thermistor (TH22) Gas pipe thermistor (TH23)	Disconnect the connector then measure the resistance with a tester. (At the ambient temperature of 10°C~30°C) <table border="1" style="margin-left: 20px;"> <thead> <tr> <th>Normal</th> <th>Abnormal</th> </tr> </thead> <tbody> <tr> <td>4.3kΩ~9.6kΩ</td> <td>Open or short</td> </tr> </tbody> </table> (Refer to Thermistor characteristic graph.)	Normal	Abnormal	4.3kΩ~9.6kΩ	Open or short										
Normal	Abnormal														
4.3kΩ~9.6kΩ	Open or short														
Vane motor (MV) 	Measure the resistance between the terminals with a tester. (At the ambient temperature of 20°C~30°C) <table border="1" style="margin-left: 20px;"> <thead> <tr> <th>Connector</th> <th>Normal</th> <th>Abnormal</th> </tr> </thead> <tbody> <tr> <td>Red - Yellow</td> <td rowspan="4" style="text-align: center; vertical-align: middle;">300Ω</td> <td rowspan="4" style="text-align: center; vertical-align: middle;">Open or short</td> </tr> <tr> <td>Red - Blue</td> </tr> <tr> <td>Red - Orange</td> </tr> <tr> <td>Red - White</td> </tr> </tbody> </table>	Connector	Normal	Abnormal	Red - Yellow	300Ω	Open or short	Red - Blue	Red - Orange	Red - White					
Connector	Normal	Abnormal													
Red - Yellow	300Ω	Open or short													
Red - Blue															
Red - Orange															
Red - White															
Drain pump (DP) (Option) 	Measure the resistance between the terminals with a tester. (Winding temperature 20°C) <table border="1" style="margin-left: 20px;"> <thead> <tr> <th>Normal</th> <th>Abnormal</th> </tr> </thead> <tbody> <tr> <td>290Ω</td> <td>Open or short</td> </tr> </tbody> </table>	Normal	Abnormal	290Ω	Open or short										
Normal	Abnormal														
290Ω	Open or short														
Drain float switch (FS)  (Option)	Measure the resistance between the terminals with a tester. <table border="1" style="margin-left: 20px;"> <thead> <tr> <th>State of moving part</th> <th>Normal</th> <th>Abnormal</th> </tr> </thead> <tbody> <tr> <td>UP</td> <td>Short</td> <td>Other than short</td> </tr> <tr> <td>DOWN</td> <td>Open</td> <td>Other than open</td> </tr> </tbody> </table> 	State of moving part	Normal	Abnormal	UP	Short	Other than short	DOWN	Open	Other than open					
State of moving part	Normal	Abnormal													
UP	Short	Other than short													
DOWN	Open	Other than open													
Linear expansion valve (LEV) 	Disconnect the connector then measure the resistance value with a tester. <table border="1" style="margin-left: 20px;"> <thead> <tr> <th colspan="4">Normal</th> <th>Abnormal</th> </tr> </thead> <tbody> <tr> <td>White-Red</td> <td>Yellow-Brown</td> <td>Orange-Red</td> <td>Blue-Brown</td> <td rowspan="2" style="text-align: center; vertical-align: middle;">Open or short</td> </tr> <tr> <td colspan="4" style="text-align: center;">200Ω ±10%</td> </tr> </tbody> </table> Refer to 8-1-2.	Normal				Abnormal	White-Red	Yellow-Brown	Orange-Red	Blue-Brown	Open or short	200Ω ±10%			
Normal				Abnormal											
White-Red	Yellow-Brown	Orange-Red	Blue-Brown	Open or short											
200Ω ±10%															

8-1-1. Thermistor

<Thermistor characteristic graph>

Thermistor for lower temperature

Room temperature thermistor (TH21)
Liquid pipe temperature thermistor (TH22)
Gas pipe temperature thermistor (TH23)

Thermistor $R_0=15k\Omega \pm 3\%$
Fixed number of $B=3480 \pm 2\%$

$$R_t = 15 \exp \left\{ 3480 \left(\frac{1}{273+t} - \frac{1}{273} \right) \right\}$$

0°C	15kΩ
10°C	9.6kΩ
20°C	6.3kΩ
25°C	5.4kΩ
30°C	4.3kΩ
40°C	3.0kΩ

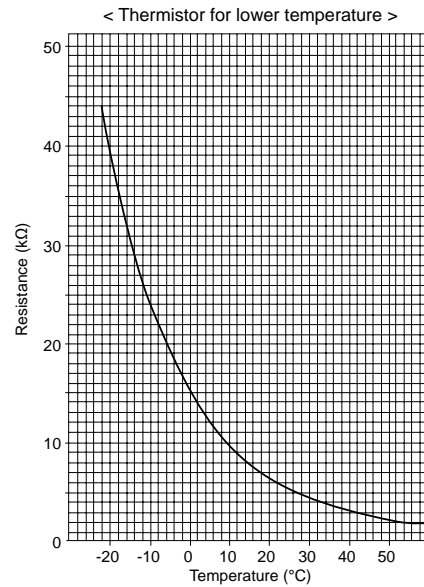

8-1-2. Linear expansion valve

① Operation summary of the linear expansion valve

- Linear expansion valves open/close through the use of a stepping motor after receiving the pulse signal from the indoor controller board.
- Valve position can be changed in proportion to the number of pulse signals.

<Connection between the indoor controller board and the linear expansion valve>

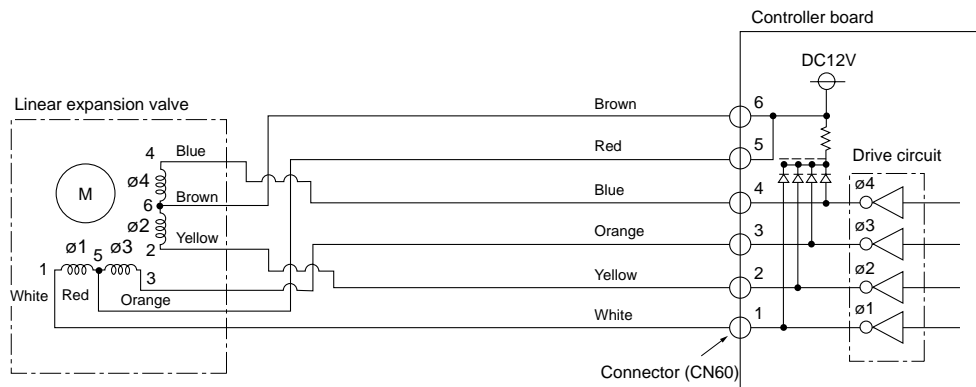

Note : Since the number of the connector at the controller board side and the relay connector are different, follow the color of the lead wire.

<Output pulse signal and the valve operation>

Output (Phase)	Output			
	1	2	3	4
$\phi 1$	ON	OFF	OFF	ON
$\phi 2$	ON	ON	OFF	OFF
$\phi 3$	OFF	ON	ON	OFF
$\phi 4$	OFF	OFF	ON	ON

Closing a valve : 1 → 2 → 3 → 4 → 1
 Opening a valve : 4 → 3 → 2 → 1 → 4
 The output pulse shifts in above order.

Note:

- When linear expansion valve operation stops, all output phase become OFF.
- At phase interruption or when phase does not shift in order, motor does not rotate smoothly and motor will lock and vibrate.

② Linear expansion valve operation

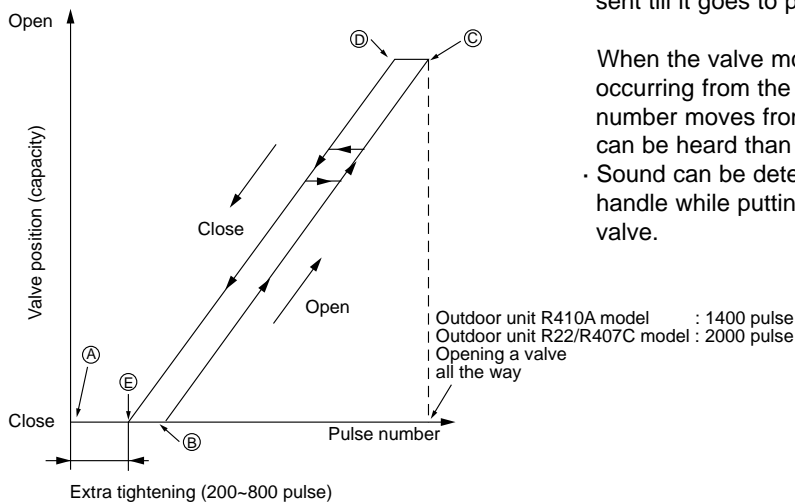

- When the switch is turned on, 2200 pulse closing valve signal will be sent till it goes to point ㉞ in order to define the valve position.

When the valve moves smoothly, there is no sound or vibration occurring from the linear expansion valves, however, when the pulse number moves from ㉞ to ㉞ or when the valve is locked, more sound can be heard than in a normal situation.

- Sound can be detected by placing the ear against the screw driver handle while putting the screw driver tip to the linear expansion valve.

③ Troubleshooting

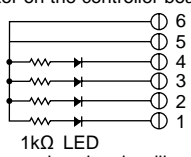
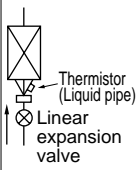
Symptom	Check points	Countermeasures
Operation circuit failure of the micro processor	Disconnect the connector on the controller board, then connect LED for checking.  1kΩ LED When power is turned on, pulse signals will output for 10 seconds. There must be some defects in the operation circuit if the LED does not light while the signals are output or keeps lighting even after the signals stop.	Exchange the indoor controller board at drive circuit failure.
Linear expansion valve mechanism is locked.	Motor will idle and make a ticking noise when the motor is operated while the linear expansion valve is locked. This ticking sound is the sign of the abnormality.	Exchange the linear expansion valve.
Short or breakage of the motor coil of the linear expansion valve	Measure the resistance between each coil (white-red, yellow-brown, orange-red, blue-brown) using a tester. It is normal if the resistance is in the range of 200Ω ±10%.	Exchange the linear expansion valve.
Valve does not close completely.	To check the linear expansion valve, operate the indoor unit in fan mode and at the same time operate other indoor units in cooling mode, then check the pipe temperature <liquid pipe temperature> of the indoor unit by the outdoor multi controller board operation monitor. During fan operation, linear expansion valve is closed completely and if there is any leaking, detecting temperature of the thermistor will go lower. If the detected temperature is much lower than the temperature indicated in the remote controller, it means the valve is not closed all the way.  Thermistor (Liquid pipe) Linear expansion valve It is not necessary to exchange the linear expansion valve, if the leakage is small and not affecting normal operation.	If large amount of refrigerant is leaked, exchange the linear expansion valve.
Wrong connection of the connector or contact failure	Check the color of lead wire and missing terminal of the connector.	Disconnect the connector at the controller board, then check the continuity.

8-1-3. DC Fan motor (fan motor/indoor controller circuit board)

Check method of DC fan motor (fan motor/indoor controller circuit board)

① Notes

- High voltage is applied to the connector (CNMF) for the fan motor. Pay attention to the service.
- Do not pull out the connector (CNMF) for the motor with the power supply on.
(It causes trouble of the indoor controller circuit board and fan motor.)





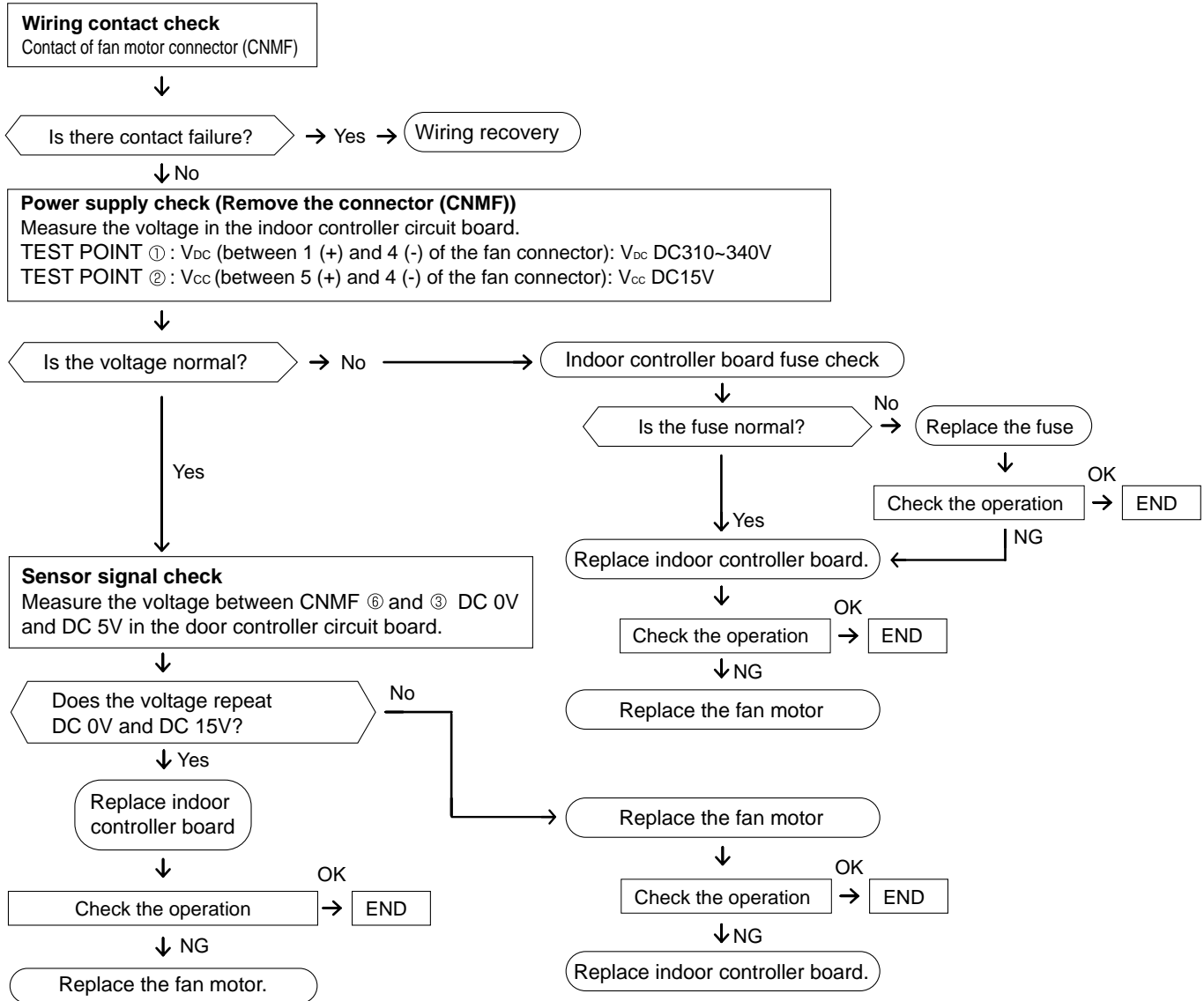





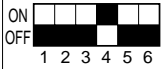
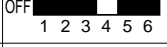

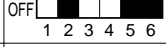

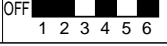

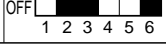
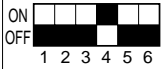
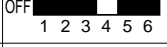

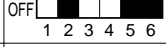

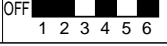
② Self check

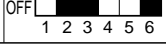
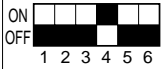
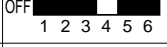
Symptom : The indoor fan cannot turn around.

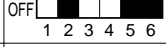

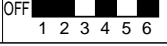
8-2. FUNCTION OF DIP SWITCH

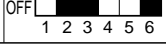





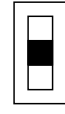

The black square (■) indicates a switch position.

Switch	Pole	Function	Operation by switch		Effective timing	Remarks															
			ON	OFF																	
SW1 Function setting	1	Thermistor <Room temperature detection> position	Built-in remote controller	Indoor unit	Under suspension	<div style="border: 1px solid black; padding: 2px;">Address board</div> <div style="border: 1px solid black; padding: 2px; margin-top: 5px;"><Initial setting></div> <div style="margin-top: 5px;"> ON  </div> <div style="margin-top: 5px;"> Note : *1 Fan operation at heating mode *2 Thermo ON operation at heating mode *3 <table border="1" style="margin-top: 5px; width: 100%; text-align: center;"> <tr> <td>SW1-7</td> <td>SW1-8</td> <td></td> </tr> <tr> <td>OFF</td> <td>OFF</td> <td>Extra low</td> </tr> <tr> <td>ON</td> <td>OFF</td> <td>Low</td> </tr> <tr> <td>OFF</td> <td>ON</td> <td>Setting airflow</td> </tr> <tr> <td>ON</td> <td>ON</td> <td>Stop</td> </tr> </table> </div>	SW1-7	SW1-8		OFF	OFF	Extra low	ON	OFF	Low	OFF	ON	Setting airflow	ON	ON	Stop
	SW1-7	SW1-8																			
	OFF	OFF	Extra low																		
	ON	OFF	Low																		
	OFF	ON	Setting airflow																		
	ON	ON	Stop																		
	2	Filter clogging detection	Provided	Not provided																	
	3	Filter cleaning	2,500 hr	100 hr																	
	4	Fresh air intake	Effective	Not effective																	
	5	Switching remote display	Thermo ON signal display	Indicating fan operation ON/OFF																	
6	Humidifier control	Always operated while the heat in ON *1	Operated depends on the condition *2																		
7	Airflow set in case of Heat thermo OFF at heating mode	Low *3	Extra low *3																		
8		Setting air flow *3	Depends on SW1-7																		
9	Auto restart function	Effective	Not effective																		
10	Power ON/OFF by breaker	Effective	Not effective																		
SW2 Capacity code setting	1~6	<table border="1" style="width: 100%; text-align: center;"> <thead> <tr> <th>Capacity</th> <th>SW 2</th> <th>Capacity</th> <th>SW 2</th> </tr> </thead> <tbody> <tr> <td>P40</td> <td>ON  OFF </td> <td>P63</td> <td>ON  OFF </td> </tr> <tr> <td>P100</td> <td>ON  OFF </td> <td>P125</td> <td>ON  OFF </td> </tr> </tbody> </table>			Capacity	SW 2	Capacity	SW 2	P40	ON  OFF 	P63	ON  OFF 	P100	ON  OFF 	P125	ON  OFF 	Before power supply ON	<div style="border: 1px solid black; padding: 2px;">Indoor controller board</div> <p style="text-align: center;">Set while the unit is off.</p> <div style="border: 1px solid black; padding: 2px; margin: 5px 0;"><Initial setting></div> <p style="text-align: center;">Set for each capacity.</p>			
Capacity	SW 2	Capacity	SW 2																		
P40	ON  OFF 	P63	ON  OFF 																		
P100	ON  OFF 	P125	ON  OFF 																		
SW3 Function setting	1	Heat pump/Cooling only	Cooling only	Heat pump	Under suspension	<div style="border: 1px solid black; padding: 2px;">Indoor controller board</div> <p style="text-align: center;">Set while the unit is off.</p> <div style="border: 1px solid black; padding: 2px; margin: 5px 0;"><Initial setting></div> <div style="margin-top: 5px;"> ON  </div> <div style="margin-top: 5px;"> Note : *4 SW3-5 *5 Please do not change SW3-9 and SW3-10. See 6. WIRING DIAGRAM. *6 Each angle can be used only 1 hour when fan speed setting Low and Middle 1,2 </div>															
	2	Louver	Available	Not available																	
	3	Vane	Available	Not available																	
	4	Vane swing function in heating (wave-flow)	Available	Not available																	
	5	Vane horizontal angle	Second setting *4	First setting *4																	
	6	Vane cooling limit angle setting	Horizontal	Setting A,B,C,D																	
	7	Changing the opening of linear expansion valve	Effective	Not effective																	
	8	4-deg up (Heating mode)	Not effective	Effective																	
	9	Superheat setting temperature *5	—	—																	
	10	Sub cool setting temperature *5	—	—																	
SW4 Model Selection	1~5	When replacing the indoor controller board, make sure to set the switch to the initial setting, which is shown below. <div style="margin-top: 10px;"> ON  </div>			Before power supply ON	<div style="border: 1px solid black; padding: 2px;">Indoor controller board</div>															

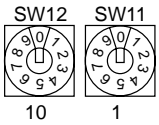
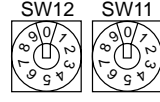
Note : *4 SW3-5

SW3-5	Vane setting	Initial setting	Setting	Vane position
OFF	Set up ①	●	Standard	Standard
ON	Set up ②		Less draft *	Upward position than the standard

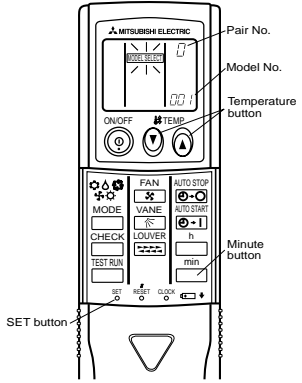
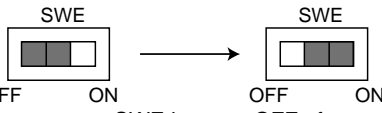
The black square (■) indicates a switch position.

Switch	Pole	Operation by switch	Effective timing	Remarks																											
SWA Ceiling height selector	1~3	<p>(High ceiling) 3</p> <p>(Standard) 2</p> <p>(Silent) 1</p>  <p>* Ceiling height can be changed depending on SWA setting.</p> <table border="1" data-bbox="526 369 1013 492"> <tr> <th>SWA</th> <th>①</th> <th>②</th> <th>③</th> </tr> <tr> <td>P40, P63</td> <td>Silent 2.5m</td> <td>Standard 2.7m</td> <td>High ceiling 3.5m</td> </tr> <tr> <td>P100, P125</td> <td>2.6m</td> <td>3.0m</td> <td>4.2m</td> </tr> </table>	SWA	①	②	③	P40, P63	Silent 2.5m	Standard 2.7m	High ceiling 3.5m	P100, P125	2.6m	3.0m	4.2m	Under operation or suspension	<p>Address board</p> <p><Initial setting></p> 															
SWA	①	②	③																												
P40, P63	Silent 2.5m	Standard 2.7m	High ceiling 3.5m																												
P100, P125	2.6m	3.0m	4.2m																												
SWC Option selector	2	<p>② オプ (Option)</p> <p>① 標 (Standard)</p>  <p>* In this model it is not necessary to change SWC to ②.</p>	Under operation or suspension	<p>Address board</p> <p><Initial setting></p> <p>② オプ</p> <p>① 標</p> 																											
SW11 1s digit address setting	Rotary switch	<p>SW12 SW11</p>  <p>How to set address</p> <p>Example : If address is "3", remain SW12 (for over 10) at "0", and match SW11 (for 1 to 9) with "3".</p>	Before power supply ON	<p>Address board</p> <p>Address can be set while the unit is stopped.</p> <p><Initial setting></p> <p>SW12 SW11</p> 																											
SW12 10ths digit address setting				<p>Address board</p> <p><Initial setting></p> <p>SW14</p> 																											
SW14 Branch No. setting	Rotary switch	<p>SW14</p>  <p>How to set branch number SW14 (Series R2 only)</p> <p>Match the indoor unit's refrigerant pipe with the BC controller's end connection number</p> <p>Remain other than series R2 at "0".</p>	Before power supply ON	<p>Address board</p> <p><Initial setting></p> <p>SW14</p> 																											
J41, J42 Wireless remote controller Pair No.	Jumper	<ul style="list-style-type: none"> To operate each indoor unit by each remote controller when installed 2 indoor units or more are near, Pair No. setting is necessary. <ol style="list-style-type: none"> Pair No. setting is available with the 4 patterns (Setting patterns A to D). Make setting for J41, J42 of indoor controller board and the Pair No. of wireless remote controller. You may not set it when operating it by 1 remote controller. <ol style="list-style-type: none"> Setting for indoor unit Jumper wire J41, J42 on the indoor controller board are cut according to the table below. Wireless remote controller pair number: Setting operation <ol style="list-style-type: none"> Press the SET button (using a pointed implement). Check that the remote controller's display has stopped before continuing. MODEL SELECT flashes, and the model No. (3 digits) appears (steadily-lit). Press the MINUTE button twice. The pair number appears flashing. Press the temperature (M) (A) buttons to select the pair number to set. Press the SET button (using a pointed implement). The set pair number is displayed (steadily-lit) for 3 seconds, then disappears. <table border="1" data-bbox="271 1657 973 1870"> <thead> <tr> <th rowspan="2">Setting pattern</th> <th colspan="2">Indoor controller Jumper wire</th> <th rowspan="2">Pair No. of wireless remote controller *</th> <th rowspan="2"></th> </tr> <tr> <th>J41</th> <th>J42</th> </tr> </thead> <tbody> <tr> <td>A</td> <td>—</td> <td>—</td> <td>0</td> <td>Factory setting</td> </tr> <tr> <td>B</td> <td>Cut</td> <td>—</td> <td>1</td> <td>—</td> </tr> <tr> <td>C</td> <td>—</td> <td>Cut</td> <td>2</td> <td>—</td> </tr> <tr> <td>D</td> <td>Cut</td> <td>Cut</td> <td>3</td> <td>—</td> </tr> </tbody> </table> <p>* Pair No.4-9 of wireless remote controller is setting pattern D.</p>	Setting pattern	Indoor controller Jumper wire		Pair No. of wireless remote controller *		J41	J42	A	—	—	0	Factory setting	B	Cut	—	1	—	C	—	Cut	2	—	D	Cut	Cut	3	—	Under operation or suspension	<p><Initial setting></p> <p>Pattern A</p> 
Setting pattern	Indoor controller Jumper wire			Pair No. of wireless remote controller *																											
	J41	J42																													
A	—	—	0	Factory setting																											
B	Cut	—	1	—																											
C	—	Cut	2	—																											
D	Cut	Cut	3	—																											
SWE Test run for Drain pump (Option)	Connector	<p>Drain pump and fan are activated simultaneously after the connector SWE is set to ON and turn on the power.</p> <p>SWE</p>  <p>OFF ON</p> <p>The connector SWE is set to OFF after test run.</p>	Under operation	<p><Initial setting></p> <p>SWE</p>  <p>OFF ON</p>																											

8-3. TEST POINT DIAGRAM

8-3-1. Indoor controller board

PCFY-P40VKM-E

PCFY-P63VKM-E

PCFY-P100VKM-E

PCFY-P125VKM-E

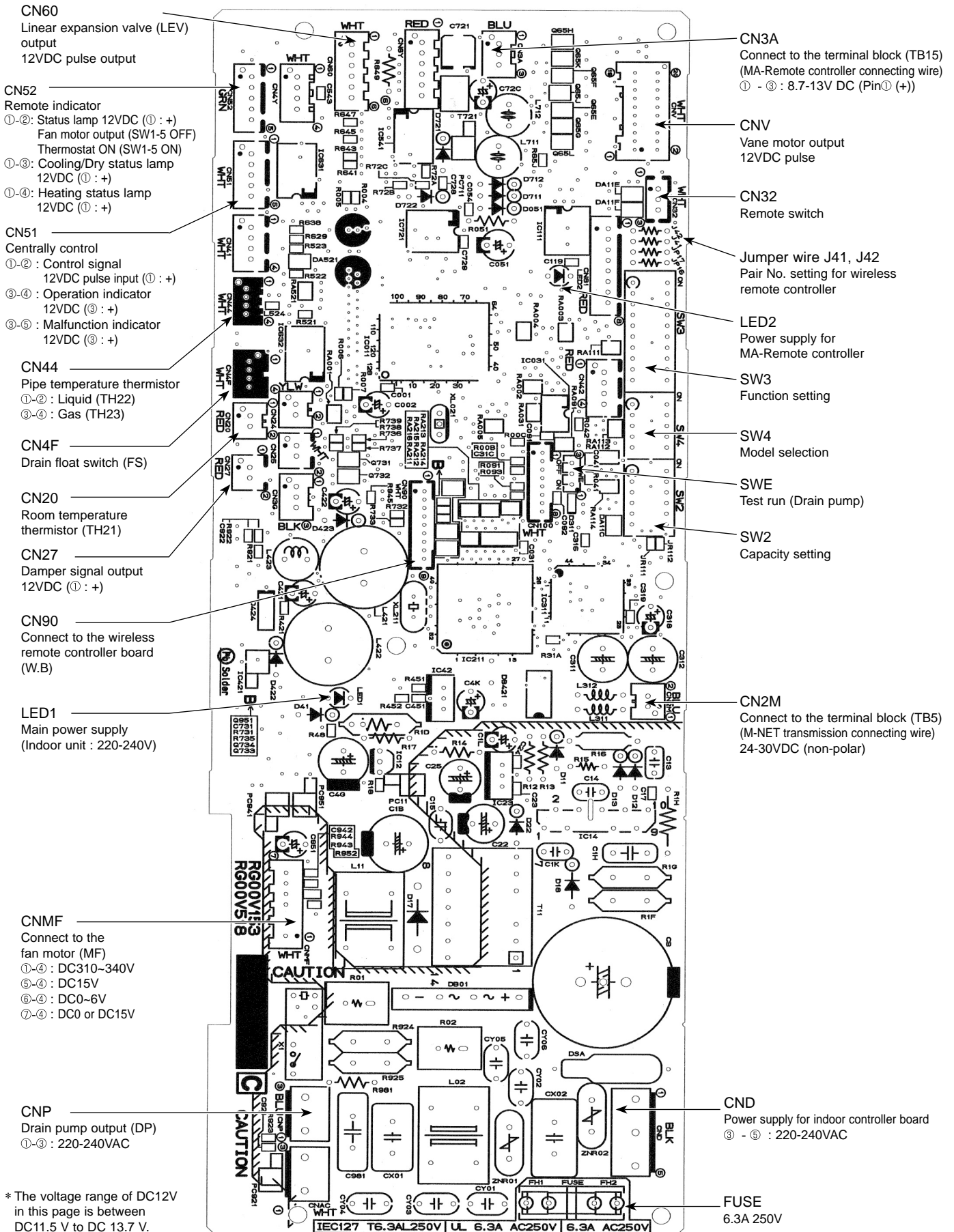

PCFY-P40VKM-ER1

PCFY-P63VKM-ER1

PCFY-P100VKM-ER1

PCFY-P125VKM-ER1

- CN60
Linear expansion valve (LEV)
output
12VDC pulse output
- CN52
Remote indicator
①-②: Status lamp 12VDC (①: +)
Fan motor output (SW1-5 OFF)
Thermostat ON (SW1-5 ON)
①-③: Cooling/Dry status lamp
12VDC (①: +)
①-④: Heating status lamp
12VDC (①: +)
- CN51
Centrally control
①-②: Control signal
12VDC pulse input (①: +)
③-④: Operation indicator
12VDC (③: +)
③-⑤: Malfunction indicator
12VDC (③: +)
- CN44
Pipe temperature thermistor
①-②: Liquid (TH22)
③-④: Gas (TH23)
- CN4F
Drain float switch (FS)
- CN20
Room temperature
thermistor (TH21)
- CN27
Damper signal output
12VDC (①: +)
- CN90
Connect to the wireless
remote controller board
(W.B)
- LED1
Main power supply
(Indoor unit : 220-240V)
- CNMF
Connect to the
fan motor (MF)
①-④: DC310-340V
⑤-④: DC15V
⑥-④: DC0-6V
⑦-④: DC0 or DC15V
- CNP
Drain pump output (DP)
①-③: 220-240VAC

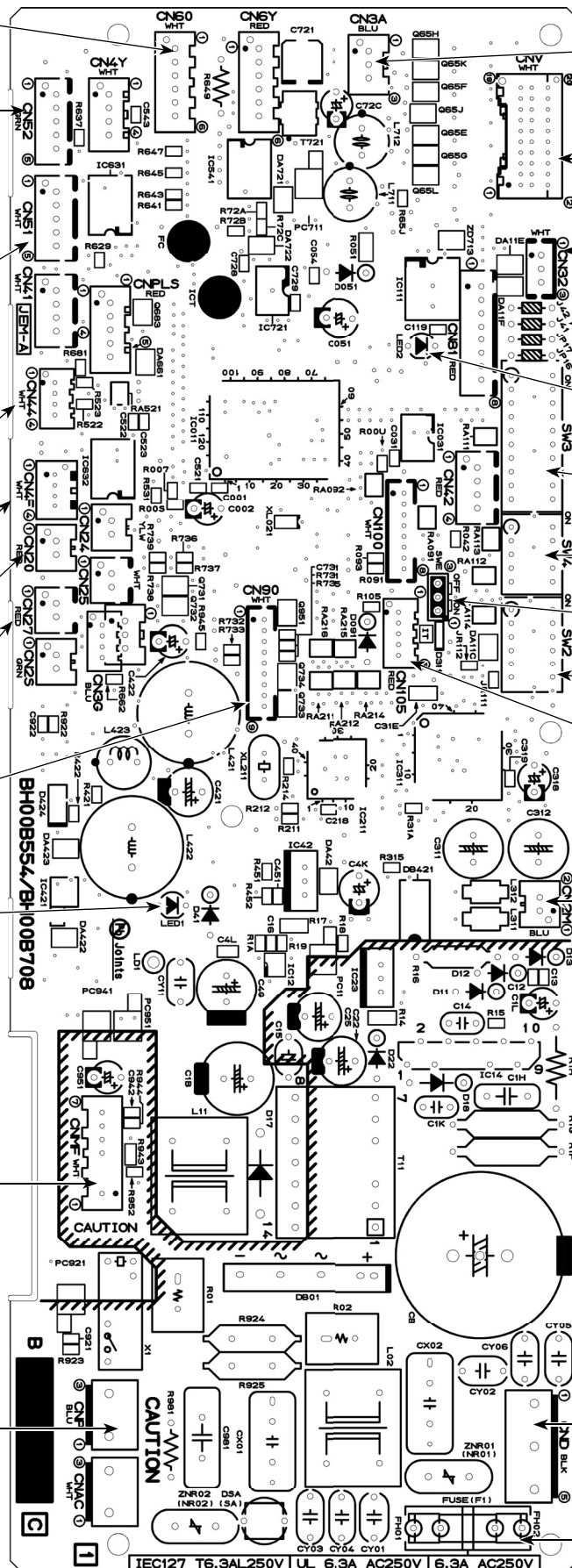

- CN3A
Connect to the terminal block (TB15)
(MA-Remote controller connecting wire)
① - ③ : 8.7-13V DC (Pin① (+))
- CNV
Vane motor output
12VDC pulse
- CN32
Remote switch
- Jumper wire J41, J42
Pair No. setting for wireless
remote controller
- LED2
Power supply for
MA-Remote controller
- SW3
Function setting
- SW4
Model selection
- SWE
Test run (Drain pump)
- SW2
Capacity setting
- CN105
- CN2M
Connect to the terminal block (TB5)
(M-NET transmission connecting wire)
24-30VDC (non-polar)

- CND
Power supply for indoor controller board
③ - ⑤ : 220-240VAC
- FUSE
6.3A 250V

* The voltage range of DC12V
in this page is between
DC11.5 V to DC 13.7 V.

8-3-2. Address board
 PCFY-P40VKM-E
 PCFY-P40VKM-ER1

PCFY-P63VKM-E
 PCFY-P63VKM-ER1

PCFY-P100VKM-E
 PCFY-P100VKM-ER1

PCFY-P125VKM-E
 PCFY-P125VKM-ER1

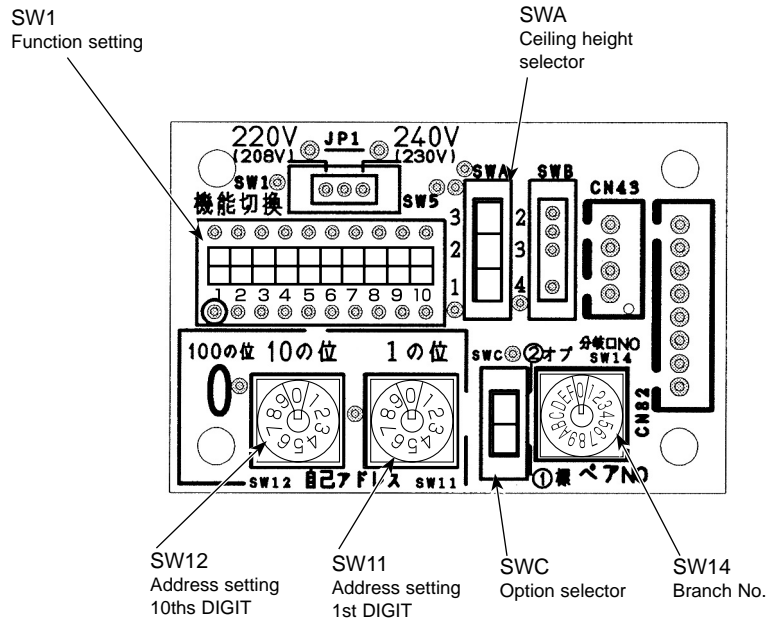

PCFY-P40VKM-E
PCFY-P40VKM-ER1

PCFY-P63VKM-E
PCFY-P63VKM-ER1

PCFY-P100VKM-E
PCFY-P100VKM-ER1

PCFY-P125VKM-E
PCFY-P125VKM-ER1

Be careful when removing heavy parts.

(Photo: PCFY-P125VKM-E)

OPERATING PROCEDURE

1. Removing the air intake grille

- (1) Slide the air intake grille holding knobs (at 2 or 3 locations) to the rear to open the air intake grille. (See Figure 1)
- (2) While the air intake grille left open, push the stoppers on the rear hinges (at 2 or 3 locations) to pull out the air intake grille. (See Figure 2)

Figure 2

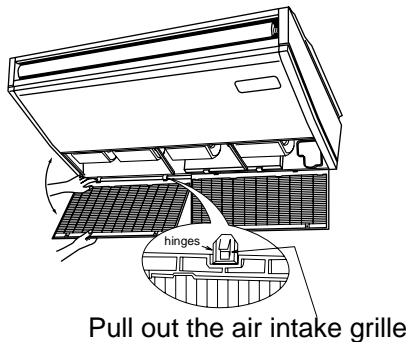

PHOTOS & ILLUSTRATIONS

Figure 1

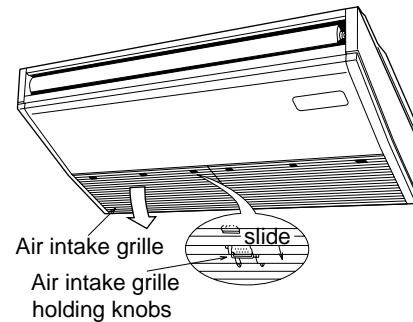

2. Removing the indoor controller board and the electrical box

- (1) Remove the air intake grille. (See Figure 1,2)
- (2) Remove the screw from the beam and remove the beam. (See Photo 1)
- (3) Remove 2 screws from the electrical cover, and remove the electrical cover.
- (4) Remove 2 screws from the electrical box and pull the electrical box downward. Temporarily secure the electrical box using 2 hooks in the back of electrical box.
- (5) Disconnect the connectors on the indoor controller board.

[Removing the electrical box]

- (6) Disconnect the wires from the terminal blocks and pull out the electrical box. (See Photo 2)

[Removing the indoor controller board]

- (6) Remove the 6 supports from the indoor controller board and remove the indoor controller board. (See Photo 3)

Photo 1

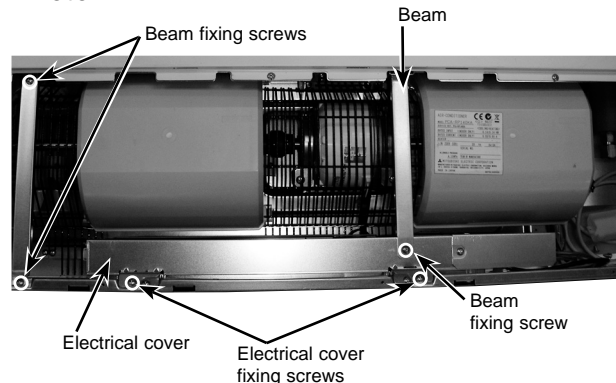

Photo 2

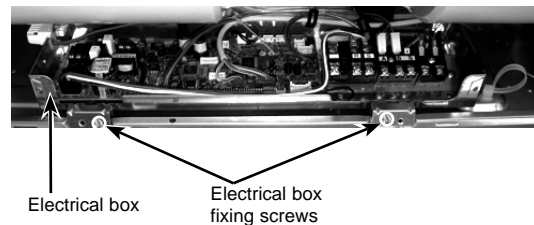
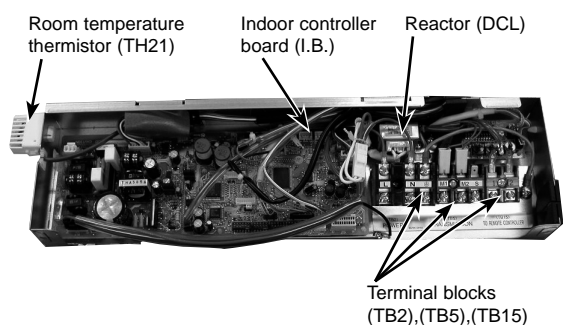

Photo 3



OPERATING PROCEDURE

3. Removing the room temperature thermistor (TH21)

- (1) Remove the air intake grille. (See Figure 1, 2)
- (2) Remove the screw from the beam and remove the beam. (See Photo 1)
- (3) Remove 2 screws from the electrical cover, and remove the electrical cover.
- (4) Remove 2 screws from the electrical box and pull the electrical box downward. Temporarily secure the electrical box using 2 hooks in the back of electrical box.
- (5) Disconnect the connector CN20 (red) from the indoor controller board.
- (6) Remove the sensor holder from the electrical box and remove the thermistor from the holder.

4. Removing the fan motor and right side fan

- (1) Remove the air intake grille. (See Figure 1, 2)
- (2) Remove the screw from the beam and remove the beam. (See Photo 1)
- (3) Remove 2 screws from the electrical cover, and remove the electrical cover.
- (4) Remove 2 screws from the electrical box and pull the electrical box downward.
- (5) Temporarily secure the electrical box using 2 hooks in the back of electrical box.
- (6) Remove 4 screws fixing fan guard of the fan motor. (2 screws : See Photo 5 / 2 screws : Upper the electrical box)
- (7) Remove 2 screws fixing fan guard of piping side and remove the fan guard. (See Photo 6)
- (8) Remove the lower casing while pressing the 4 catches of the casing (right side of the fan motor).
- (9) Loosen the 2 set screws (2 hexagon set screws) of connecting joint and slide the fan motor to the left. (See Photo 5)
- (10) Remove the motor piece (left and right, each 1 screw). (See Photo 5)
- (11) Remove the fan motor and right side fan together.
- (12) Loosen the set screw (hexagon set screw) of fan and remove the fan from the shaft. (See Photo 7, 8)

Photo 8

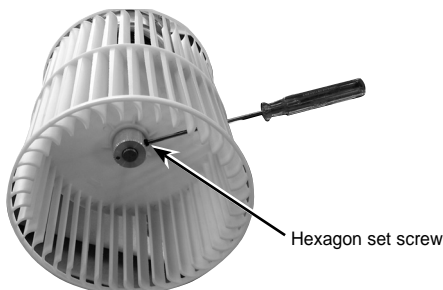

PHOTOS & ILLUSTRATIONS

Photo 4

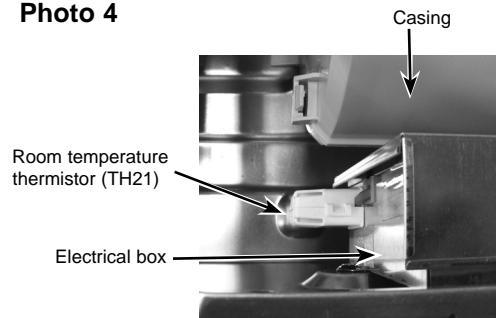

Photo 5

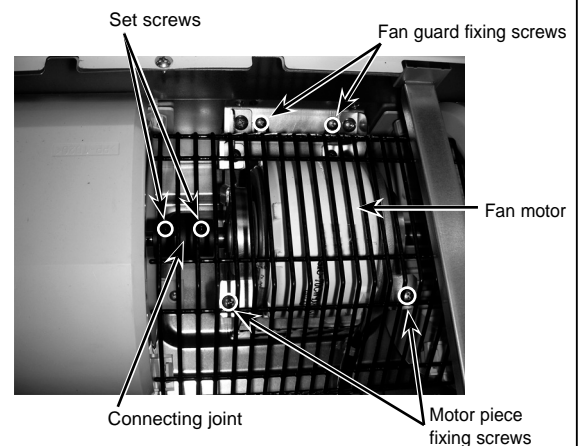

Photo 6

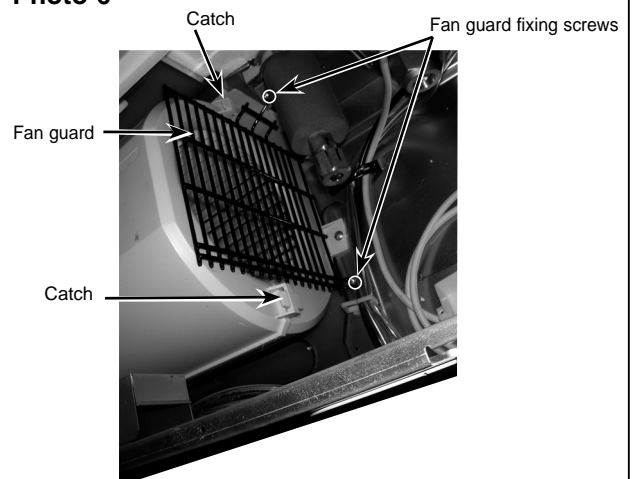
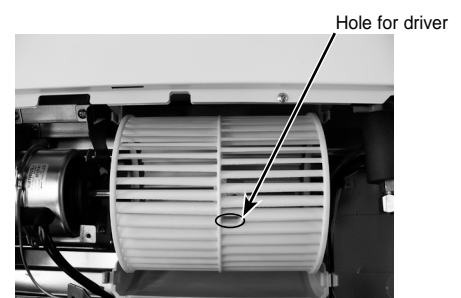

Photo 7



OPERATING PROCEDURE

5. Removing the fan (3 connection)

- (1) Remove the air intake grille. (See Figure 1, 2)
- (2) Remove the screw from the beam and remove the beam. (See Photo 1)
- (3) Remove 2 screws from the electrical cover, and remove the electrical cover.
- (4) Remove 2 screws from the electrical box and pull the electrical box downward. Temporarily secure the electrical box using 2 hooks in the back of electrical box.
- (5) Remove 4 screws from the fan guard of the fan motor. (See Photo 5)
- (6) Remove 2 screws from the left side beam and remove the beam. (See Photo 1)
- (7) Remove the 3 screws from center fan guard and remove the fan guard. (2 screws : See Photo 9 / 1 screw : Drain pan side)
- (8) Remove 2 screws from the left fan guard and remove the fan guard. (See Photo 10)
- (9) Loosen 2 set screws (2 hexagon set screws) of connecting joint. (See Photo 5)
- (10) Remove 3 lower casings while pressing each 4 catches of the casing.
- (11) Remove the 4 screws from the bearing support. (See Photo 11)
- (12) Slide the connecting joint to the left and remove the fans and shaft together. (See Photo 12)
- (13) Remove the fan from the shaft. (See Photo 7, 8)

Photo 12

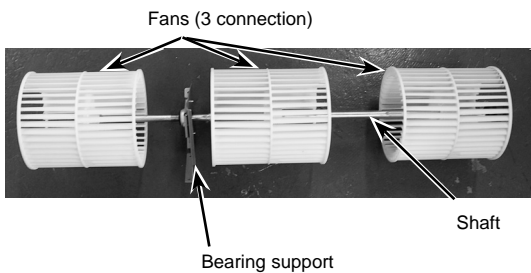

PHOTOS & ILLUSTRATIONS

Photo 9

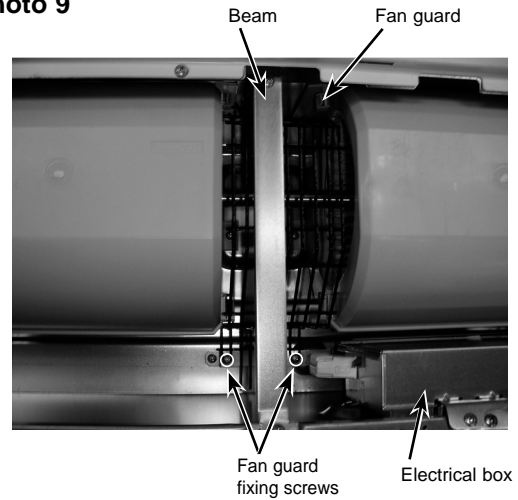

Photo 10

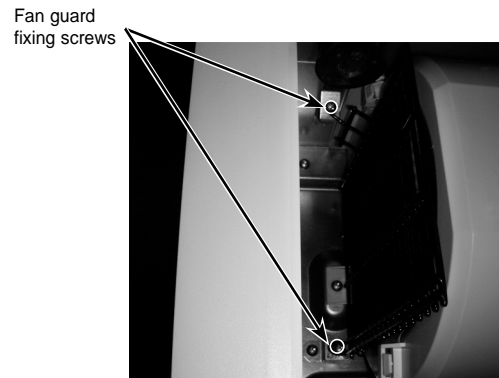

Photo 11

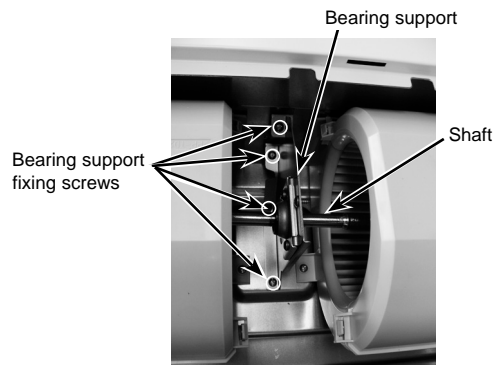
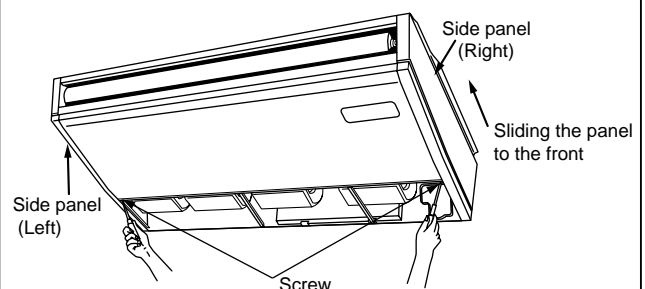

Figure 3



6. Removing the side panel

- (1) Remove the air intake grille. (See Figure 1, 2)
- (2) Remove the screw from the side panel, and remove the side panel by sliding the panel to the front.

OPERATING PROCEDURE

7. Removing the vane motor

- (1) Remove the air intake. (See Figure 1, 2)
- (2) Remove the right side panel. (See Figure 3)
- (3) Remove the connector of vane motor.
- (4) Remove 2 screws of vane motor cover, then remove vane motor.

8. Removing the under panel

- (1) Remove the air intake grille. (See Figure 1, 2)
- (2) Remove the left and right side panels. (See Figure 3)
- (3) Remove the beam. (See Photo 1)
- (4) Remove the electrical cover. (See Photo 1)
- (5) Pull the electrical box downward. (See Photo 2)
- (6) (Wireless remote controller receiver type only)
Disconnect the connector CNB from the PCB for wireless remote controller and remove the clamp and strap for wires.
- (7) Remove 8 screws from the under panel.
- (8) Move the under panel forward by about 10mm and remove the under panel.

9. Removing the drain pan

- (1) Remove the air intake grille. (See Figure 1, 2)
- (2) Remove the side panel (right and left). (See Figure 3)
- (3) Remove the under panel. (See Photo 14)
Remove the screws of the right and left side drain pan. (See Photo 15)
- (4) Remove 2 insulation in center of the drain pan, and after removing 2 screws with washer, remove the drain pan. (See Photo 16, 17)

(Note)

Please be aware that there might be some drainage left in the drain pan when you remove the drain pan.

Photo 17

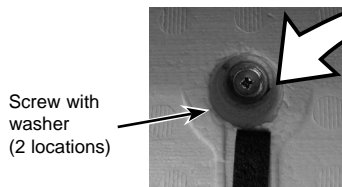

PHOTOS & ILLUSTRATIONS

Photo 13

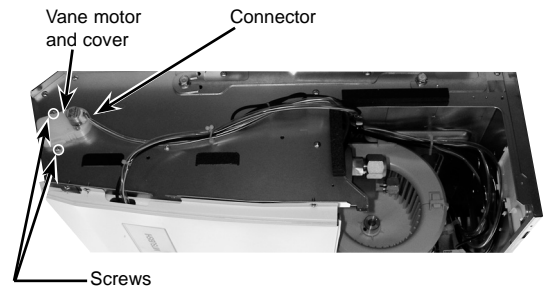

Photo 14

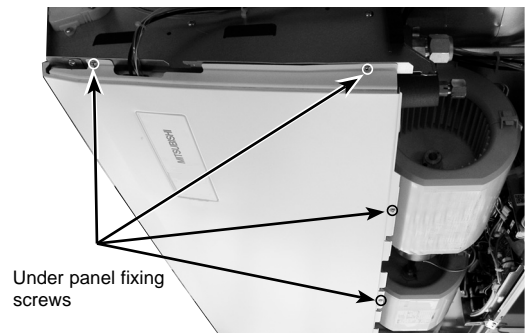

Photo 15

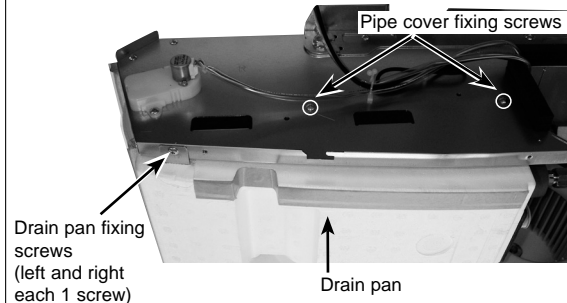
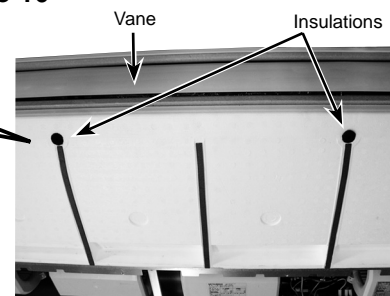

Photo 16



OPERATING PROCEDURE

10. Removing the pipe thermistors / Liquid (TH22) and Gas (TH23)

- (1) Remove the air intake grille. (See Figure 1, 2)
- (2) Remove the left and right side panels. (See Figure 3)
- (3) Remove the under panel. (See Photo 14)
- (4) Remove the drain pan. (See Photo 15, 16, 17)
- (5) Disconnect the connector CN44 (white) from the indoor controller board.
- (6) Remove 6 screws from the pipe cover and remove the pipe cover. (See Photo 15, 18)
- (7) Remove the fastener for wires and remove the thermistors (liquid and gas) from each holder. (See Photo 19)

PHOTOS & ILLUSTRATIONS

Photo 18

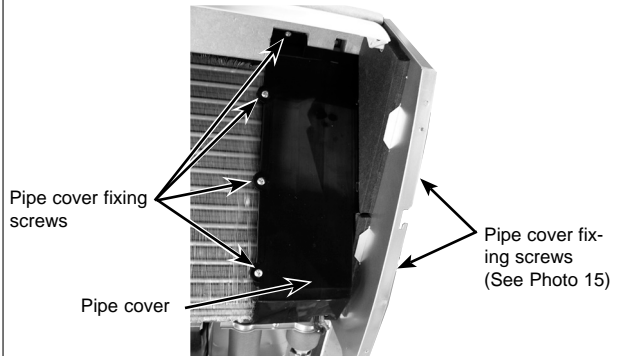
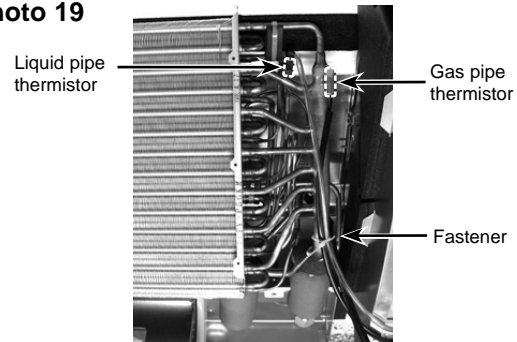

Photo 19



11. Removing the guide vane

- (1) Remove the intake grille. (See Figure 1, 2)
- (2) Remove the side panel (right and left). (See Figure 3)
- (3) Remove the under panel. (See Photo 14)
- (4) Remove the drain pan. (See Photo 15, 16, 17)
- (5) Remove the screw from the guide vane, then remove the guide vane.

Photo 20

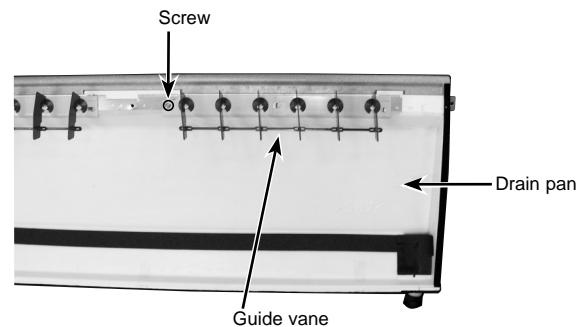

12. Removing the Auto vane

- (1) Remove the intake grille. (See Figure 1, 2)
- (2) Remove the right side panel. (See Figure 3)
- (3) Remove the vane motor and cover. (See Photo 13)
- (4) Slide the auto vane to the vane motor side.
- (5) Remove 2 axes from each vane support pushing the vane support to the vane sleeve side.

Photo 21

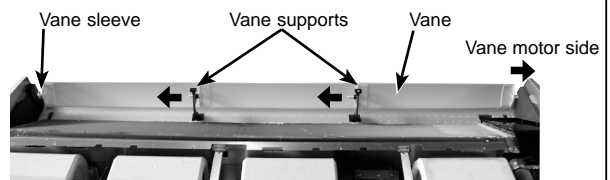

OPERATING PROCEDURE

13. Removing the heat exchanger and LEV

- (1) Remove the air intake grille. (See Figure 1, 2)
- (2) Remove the beam. (See Photo 1)
- (3) Remove the electrical cover. (See Photo 1)
- (4) Pull the electrical box downward. (See Photo 2)
- (5) Disconnect the connector CN60 (white) from the indoor controller board.
- (6) Remove the left and right side panels. (See Figure 3)
- (7) Remove the under panel. (See Photo 14)
- (8) Remove the drain pan. (See Photo 15, 16, 17)
- (9) Remove the pipe cover. (See Photo 18)
- (10) Remove the pipe thermistors (TH22 and TH23) from each holder. (See Photo 19)
- (11) Remove the pipe band fixing screw and remove the pipe band. (See Photo 22)
- (12) Remove 2 screws from the heat exchanger and remove the heat exchanger with LEV.

PHOTOS & ILLUSTRATIONS

Photo 22

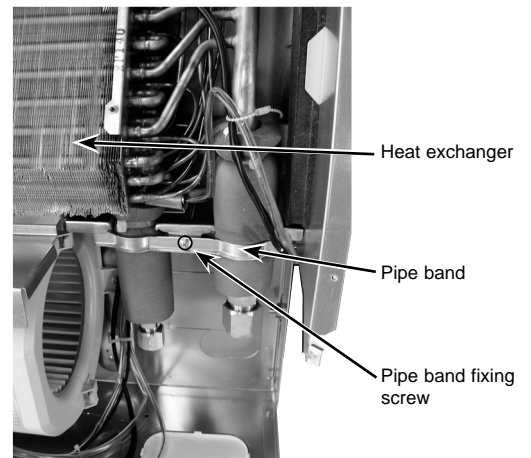
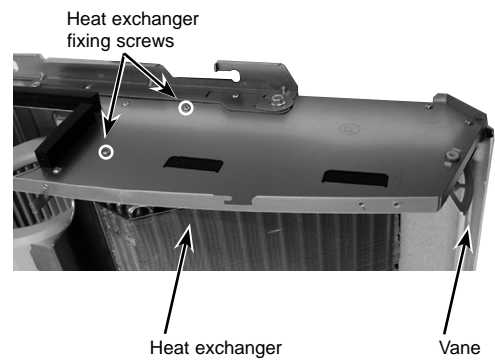

Photo 23



CITY MULTI™

MITSUBISHI ELECTRIC CORPORATION

HEAD OFFICE : TOKYO BLDG., 2-7-3, MARUNOUCHI, CHIYODA-KU TOKYO 100-8310, JAPAN
